

# TRACKER 5600

## CHARTPLOTTERS

### Installation and Operation Manual



# NAVMAN

### **FCC Statement**

Note: This equipment has been tested and found to comply with the limits for a Class B digital device, pursuant to Part 15 of the FCC Rules. These limits are designed to provide reasonable protection against harmful interference in a normal installation. This equipment generates, uses and can radiate radio frequency energy and, if not installed and used in accordance with the instructions, may cause harmful interference to radio communications. However, there is no guarantee that interference will not occur in a particular installation. If this equipment does cause harmful interference to radio or television reception, which can be determined by turning the equipment off and on, the user is encouraged to try to correct the interference by one or more of the following measures:

- Reorient or relocate the receiving antenna.
- Increase the separation between the equipment and receiver.
- Connect the equipment into an output on a circuit different from that to which the receiver is connected.
- Consult the dealer or an experienced technician for help.
- A shielded cable must be used when connecting a peripheral to the serial ports.

# Contents

|   |           |
|---|-----------|
| <b>1 Introduction</b>                             | <b>6</b>  |
| 1-1 Care  | 6         |
| 1-2 Plug-in cards                                 | 6         |
| 1-3 Removing and replacing the display unit       | 7         |
| <b>2 Basic operation</b>                          | <b>8</b>  |
| 2-1 Turning on and off / auto power               | 9         |
| 2-2 The main displays                             | 9         |
| 2-3 Adjusting the backlight                       | 10        |
| 2-4 Man overboard (MOB)                           | 10        |
| 2-5 Alarms  | 10        |
| 2-6 Simulate mode                                 | 10        |
| 2-7 Navigating                                    | 11        |
| <b>3 Chart</b>                                    | <b>12</b> |
| 3-1 Chart display                                 | 12        |
| 3-1-1 Chart modes                                 | 12        |
| 3-1-2 Latitude and longitude                      | 13        |
| 3-1-3 Chart scale                                 | 13        |
| 3-1-4 The compass                                 | 13        |
| 3-1-5 Chart symbols                               | 13        |
| 3-1-6 Chart information                           | 13        |
| 3-1-7 Find nearby services                        | 13        |
| 3-1-8 Change the data display and compass display | 13        |
| 3-2 Distance and bearing calculator               | 14        |
| 3-3 Goto  | 14        |
| 3-4 Projected course                              | 15        |
| 3-5 Tracks and tracking                           | 15        |
| <b>4 Fuel display</b>                             | <b>16</b> |
| <b>5 Data display</b>                             | <b>16</b> |
| <b>6 Highway display</b>                          | <b>17</b> |
| <b>7 Satellites</b>                               | <b>17</b> |
| 7-1 Satellite display                             | 18        |
| <b>8 Tides display</b>                            | <b>19</b> |
| <b>9 Waypoints</b>                                | <b>20</b> |
| 9-1 Waypoints display                             | 20        |
| 9-2 Managing waypoints                            | 20        |
| 9-2-1 Creating a new waypoint                     | 20        |
| 9-2-2 Moving a waypoint                           | 21        |
| 9-2-3 Editing a waypoint                          | 21        |
| 9-2-4 Displaying a waypoint on the chart          | 21        |
| 9-2-5 Deleting a waypoint                         | 21        |
| 9-2-6 Deleting all waypoints                      | 21        |
| 9-2-7 Changing a waypoint's data                  | 21        |
| 9-2-8 Sort waypoints                              | 21        |

|  |            |
|--|------------|
| <b>110 Routes</b>                                | <b>22</b>  |
| 10-1 Routes display                              | 22         |
| 10-2 Managing routes                             | 22         |
| 10-2-1 Creating a new route                      | 22         |
| 10-2-2 Editing a route                           | 23         |
| 10-2-3 Displaying a route on the chart           | 23         |
| 10-2-4 Deleting a route                          | 23         |
| 10-2-5 Deleting all routes                       | 23         |
| 10-3 Navigating a route                          | 23         |
| 10-3-1 Starting a route                          | 23         |
| 10-3-2 Skipping a waypoint in a route            | 23         |
| 10-3-3 Cancelling a route                        | 23         |
| <b>11 User card display</b>                      | <b>24</b>  |
| <b>12 About display</b>                          | <b>25</b>  |
| <b>13 Setup menu</b>                             | <b>25</b>  |
| 13-1 System setup                                | 25         |
| 13-2 Chart setup                                 | 27         |
| 13-3 DGPS setup                                  | 28         |
| 13-4 Fuel Setup                                  | 28         |
| 13-5 Track setup                                 | 29         |
| 13-6 Trip log(s) setup                           | 29         |
| 13-7 Alarms setup                                | 30         |
| 13-8 Units setup                                 | 30         |
| 13-9 Comms setup                                 | 30         |
| 13-10 Time setup                                 | 31         |
| 13-11 Simulate setup                             | 31         |
| <b>14 Systems of several instruments</b>         | <b>31</b>  |
| <b>15 Installation</b>                           | <b>32</b>  |
| 15-1 What comes with the TRACKER                 | 32         |
| 15-2 Options and accessories                     | 32         |
| 15-3 Installation                                | 33         |
| <b>Appendix A - Specifications</b>               | <b>36</b>  |
| <b>Appendix B - Troubleshooting</b>              | <b>38</b>  |
| <b>Appendix C - Glossary and navigation data</b> | <b>39</b>  |
| <b>Appendix D - How to contact us</b>            | <b>119</b> |

## Important

It is the owner's sole responsibility to install and use the instrument in a manner that will not cause accidents, personal injury or property damage. The user of this product is solely responsible for observing safe boating practices.

**Global Positioning System:** The Global Positioning System (GPS) is operated by the US Government which is solely responsible for its operation, accuracy and maintenance. The GPS system is subject to changes which could affect the accuracy and performance of all GPS equipment anywhere in the world including the TRACKER. Whilst the NAVMAN TRACKER is a precision navigation instrument, it can be misused or misinterpreted, which can result in its use being unsafe. To reduce the risk of misusing or misinterpreting the TRACKER, the user must read and understand all aspects of this Installation and Operation manual. We also suggest that the user practice all operations using the built in simulator before using the TRACKER at sea.

**Electronic Chart:** The electronic chart used by the TRACKER is an aid to navigation and is designed to supplement the use of official government charts not replace them. Only official government charts supplemented by notices to mariners contain the information required for safe and prudent navigation. Always supplement the information provided by the TRACKER with other plotting sources such as observations, depth soundings, radar and hand compass bearings. Should the information not agree then the discrepancy must be resolved before proceeding any further.

**Fuel Computer:** Fuel economy can alter drastically depending on the boat loading and sea conditions. The fuel computer should not be the sole source of information concerning available fuel onboard and the electronic information should be supplemented by visual or other checks of the fuel load. This is necessary due to possible operator induced errors such as forgetting to reset the fuel used when filling the tank, running the engine with the fuel computer not switched on or other operator controlled actions that may render the device inaccurate. Always ensure that adequate fuel is carried onboard for the intended trip plus a reserve to allow for unforeseen circumstances.

NAVMAN NZ LIMITED DISCLAIMS ALL LIABILITY FOR ANY USE OF THIS PRODUCT IN A WAY THAT MAY CAUSE ACCIDENTS, DAMAGE OR THAT MAY VIOLATE THE LAW.

**Governing Language:** This statement, any instruction manuals, user guides and other information relating to the product (Documentation) may be translated to, or has been translated from, another language (Translation). In the event of any conflict between any Translation of the Documentation, the English language version of the Documentation will be the official version of the Documentation.

*This manual represents the TRACKER as at the time of printing. Navman NZ Limited reserves the right to make changes to specifications without notice.*

Copyright © 2002 Navman NZ Limited, New Zealand, all rights reserved. NAVMAN is a registered trademark of Navman NZ Limited.

# 1 Introduction

## TRACKER chartplotters

NAVMAN's TRACKER chartplotters are compact, ruggedly built, highly integrated navigation instruments. They have been designed to be easy to use. Complex navigation functions can be performed with a few key presses, taking the hard work out of navigation.

This manual covers the NAVMAN TRACKER 5600 chartplotter, which has a large, easy to read colour display and uses an external GPS antenna.

The TRACKER has a built-in chart of the world, suitable for route planning and general interest. To see chart details for a region, plug in a C-MAP™ chart card (an electronic chart).

The TRACKER receives information from the GPS system and displays the boat's position and speed.

The TRACKER can navigate to a point or can navigate along a route. When the boat is navigating to one of

these points, the TRACKER displays course information for the helmsman to follow.

The TRACKER can control an autopilot and can display depth information from a depth sounder. With an optional fuel kit, the TRACKER becomes a sophisticated yet easy to use fuel computer. Navigation data can be saved to a plug-in user card so that it can be easily transferred to another NAVMAN chartplotter.

The TRACKER is part of the NAVMAN family of instruments, which includes instruments for speed, depth, wind and repeaters. These instruments can be connected together to form an integrated data system (see section 14).

For maximum benefit, please read this manual carefully before installing and using the unit. Special terms are explained in Appendix C.

## 1-1 Care

### Cleaning and maintenance

Caution should be used when cleaning the TRACKER, and especially the screen of the TRACKER. Only use a clean sponge or chamois soaked in fresh water and mild detergent. Never use a dry cloth as this may drag dried salt crystals across the screen resulting in scratching. Do not use any form of abrasive cleaner, solvent, petrol or other chemical cleaner.

Push the dust cover over the display when the TRACKER is turned off.

### Plug-in cards

Handle plug-in cards carefully. Keep them in their protective cases when not plugged into the TRACKER.

If a card gets dirty or wet, clean it with a damp cloth or mild detergent.

Keep the card holder in place in the display unit at all times to prevent moisture from entering the card compartment.

## 1-2 Plug-in cards

The TRACKER can use two kinds of plug-in cards:

- **C-MAP™ chart card** have chart details required for navigating in a particular region. When a chart card is plugged in, the extra details automatically appear on the TRACKER's chart display.
- **C-MAP™ user cards** are used to store navigation data. Each user card expands the TRACKER's memory and allows the data to be transferred to another TRACKER easily (see section 11).

**Note:** *The older 5 volt cards are not supported.*

When a card is inserted or removed it does not matter if the TRACKER is turned on or off.

## Changing the plug-in card



1 Pull card holder out of TRACKER.



2 Pull any card out of holder. Put card in case.

Gold contacts under here

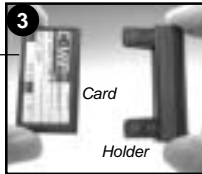

3 Push new card into holder. Ensure the gold contacts are on the outer edge and underneath (see above). Keep the card's case.



4 Push card holder fully into TRACKER.

**⚠ Warning: Keep the holder in place in the TRACKER at all times to prevent moisture from entering card compartment.**

## 1-3 Removing and replacing the display unit

If the display unit is bracket mounted then the display unit can easily be removed and replaced for security or protection.

### Removing the display unit:

- 1 Turn the TRACKER off by holding  until the display turns off.
- 2 Push the dust cover over the display unit.
- 3 Hold the display unit with one hand. Loosen the knob on the mounting bracket and carefully lift the unit off the mounting bracket.
- 4 The display unit has some cables plugged into the back.  
Unplug each black plug by turning the locking collar a quarter turn anticlockwise and pulling the plug out.  
If there is a gold plug, unscrew the locking collar anticlockwise and pull the plug out.
- 5 Push the attached dust covers over the exposed ends of the plugs to protect them.
- 6 Store the display unit in a safe place, such as the optional NAVMAN carry bag.



### Replacing the display unit

- 1 Remove the dust covers from the plugs. Plug the black plugs into their sockets on the back of the display unit:
  - Match the colour on the end of the plug to the colour of the nut on the socket.
  - Hold the plug against the socket and rotate the plug until it slides into the socket.
  - Lock the plug in place by pushing the locking collar towards the socket and turning it a quarter turn clockwise.  
Nothing will be damaged if a cable is plugged into the wrong socket by mistake.
- 2 If the unit has a gold plug:
  - Plug it into its socket on the back of the display unit.
  - Hand tighten the locking collar clockwise - do not overtighten.
- 3 Hold the display unit in place on the mounting bracket shaft, with the rubber washer clamped between the bracket and the display unit.
- 4 Adjust the tilt and rotation of the display for best viewing and hand tighten the knob on the mounting bracket. Remove the dust cover.

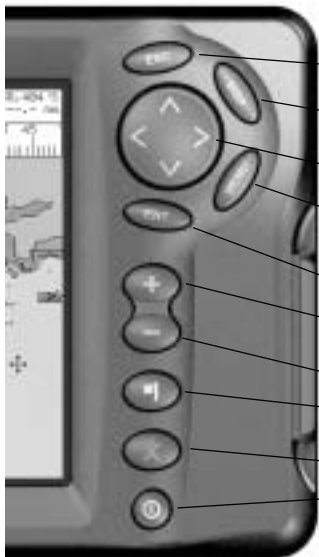
## 2 Basic operation



### Overview of the keys

- ESC** Go back to an earlier menu or display. Any changes are ignored.
- DISP** Show a menu of the main TRACKER displays. To go to a display, select it from the menu (see section 2-2).
- ▲, >, ▼, <** Cursor keys, to move the cursor or the selection highlight.
- MENU** Show a menu of the options for the current display. Press **MENU** again to display the setup menu (see section 13).
- ENT** Start an action or accept a change.
- +** Zoom in and display a smaller area of the chart in more detail.
- Zoom out and display a bigger area in less detail.
-  Create an instant waypoint at the boat position (see section 9-2-1).
-  Man overboard (MOB, see section 2-4).
-  Turn TRACKER on and off (see section 2-1); adjust the backlighting (see section 2-3).

### Keys

In this manual:

**Press** means to push the key for less than a second.

**Hold** means to hold the key down.

The internal beeper beeps when a key is pressed (to disable or enable the beep, see section 13-1).

#### To select an item in a menu

The TRACKER is operated by selecting items from menus shown on the display.

- 1 Press **▼** or **▲** to move the highlight to the item.
- 2 Press **ENT** or **>** to select the item.

#### Change a number or word

To change a number or word on the display:

- 1 Press **<** or **>** to move the highlight to the digit or letter to change.

Press **▼** or **▲** to change the digit or letter.

- 2 Repeat the above step to change any other digits or letters.
- 3 Press **ENT** to accept the change.

## 2-1 Turning on and off / auto power

### Auto power

If the TRACKER is wired for auto power (see section 15-3), then the TRACKER automatically turns on and off with the boat power, and can not be turned on or off manually.

### Turning on manually

If the TRACKER is not wired for auto power, turn the unit on by pressing **☰**.

### Startup

After the TRACKER has been turned on:

- 1 The unit displays a title display for a few seconds, then beeps again and displays a navigation warning.

- 2 If necessary, adjust the display to be easy to read (see section 2-3).

Read the warning and press **ENT**.

- 3 The satellite display is shown.
  - Either wait for the GPS receiver to start up and the status to change from 'acquiring' to 'GPS fix' (see section 7-1).
  - Or press **ESC**.
- 4 The TRACKER chart is displayed (see section 3).

### Turning off manually

If the TRACKER is not wired for auto power, turn the unit off by holding down **☰** until the display turns off.

## 2-2 The main displays

After you have turned the TRACKER on, it shows the satellite display until the GPS receiver gets a GPS fix, then displays the Chart. The Chart is the display that you will normally use for navigation.

To use one of the other main displays, press **DISP** for the display menu and select a display to use.

To return to the chart display, press **ESC**.

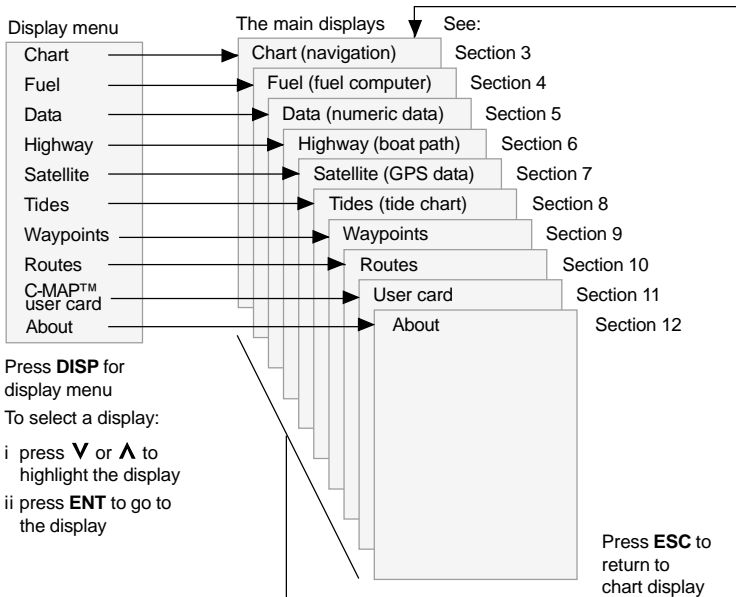

## 2-3 Backlight

- 1 Press  briefly to show the display controls.
- 2 The display and keys are backlit, with sixteen brightness levels.  
To change the backlight, press **<** (dimmer) or **>** (brighter).
- 3 Press **ENT** to accept the new values.

## 2-4 Man overboard (MOB)

The MOB feature saves the boat's position and then navigates back to this point. To do this:

- 1 Press .  
The TRACKER beeps four times and stores the boat's position as a waypoint called MOB.
- 2 The TRACKER changes to the chart display, with the MOB waypoint at the centre of the chart.  
The chart zooms in for accurate navigation. If the chart can not show the required small scale, the TRACKER changes to plotter mode (a white display with crosshatching and no chart details, see section 13-2).
- 3 If the autopilot output is off (see section 13-9) the TRACKER immediately starts navigating back to the MOB waypoint.  
If the autopilot output is on, the TRACKER asks if the autopilot is active.

Select:

**No:** The TRACKER immediately starts navigating back to the MOB waypoint.

**Yes:** The TRACKER asks if the boat is to go to the MOB waypoint.

Select:

- **Yes:** to immediately start navigating to the MOB waypoint.
- **Warning:** This might result in a sudden and dangerous turn.
- **No:** to allow time to disengage the autopilot; then use Goto to navigate back to the MOB waypoint (see section 3-3).

**To cancel MOB or set another MOB.**

- 1 Press  again to display a menu.
- 2 Select an option from the menu.

 **Tip:** The MOB waypoint remains on the chart after the MOB has been cancelled. To delete the MOB waypoint, see section 9-2-5.

## 2-5 Alarms

When the TRACKER detects an alarm condition, it displays a warning message on the display, the internal beeper sounds and any external beepers or lights operate.

Press **ESC** to clear the alarm. The alarm will sound again if the alarm condition occurs again.

The TRACKER has five user settable alarms: arrival radius, anchor, XTE, danger and low fuel see section 13-6.

In addition, the TRACKER has a fixed alarm for loss of GPS/DGPS fix.

## 2-6 Simulate mode

Simulate mode allows a user to become familiar with the TRACKER off the water. In Simulate mode, the data from the GPS receiver and other sensors is ignored and the TRACKER generates this data internally to simulate the movement of the boat. Otherwise, the TRACKER functions normally.

To see if the TRACKER is in Simulate mode, press **DISP** and select *Satellite*. If it is in Simulate mode, then it shows Simulate at the top left of the display. To start and stop Simulate mode, (see section 13-10).

 **Warning:** Never have Simulate mode on when the TRACKER is navigating on the water.

## 2-7 Navigating

The TRACKER has two ways of navigating, going straight to a point or following a route.

Enter waypoints at points of interest before starting to navigate (see section 9-2-1).

 **Tip:** Create a waypoint at the start of the trip to navigate back to.

### Goto: Going straight to a point

The TRACKER can navigate straight to a waypoint or to any arbitrary point:

- 1 In the chart display, move the cursor to the destination point to navigate to (see section 3-1-1).
- 2 Start navigating using the Goto function from the chart menu (see section 3-3).

The chart, data and highway displays show navigation data. The chart shows:

- The boat position .
- The destination point marked with a circle.
- The boat's plotted course to the destination.
- Two CDI lines, parallel to the boat's plotted course (see Appendix C, CDI).

If the TRACKER is connected to an autopilot, the TRACKER will send data to the autopilot to steer the boat to the destination.

If the XTE alarm is enabled, an alarm will sound if the boat deviates too much from its intended course (to set the XTE alarm, see section 13-7).

- 3 If the arrival radius alarm is enabled, then, when the boat comes within the arrival radius of the destination, an alarm will sound to show that the boat has reached the destination (to set the arrival radius alarm, see section 13-7).
- 4 To stop the Goto, see section 3-3.

### Following a route

A route is a list of waypoints that the boat can follow (see section 10).

- 1 To create waypoints before creating the route, use the waypoints display (see section 9-2-1).
- 2 To create a route, go to the chart or routes display (see section 10-2-1).
- 3 To start the route, see section 10-3-1.

The chart, data and highway displays show navigation data. The chart shows:

- The boat position .
- The waypoint at the end of the current leg marked with a circle.
- The boat's plotted course along the leg.
- Two CDI lines, parallel to the boat's plotted course (see Appendix C, CDI).

If the TRACKER is connected to an autopilot, the TRACKER will send data to the autopilot to steer the boat to the destination.

If the XTE alarm is enabled, an alarm will sound if the boat deviates too much from its intended course (see section 13-7).

If the arrival radius alarm is enabled, then, when the boat comes within the arrival radius of the waypoint at the end of the current leg, an alarm will sound (to set the arrival radius alarm, see section 13-7).

- 4 The TRACKER stops navigating to the waypoint at the end of the current leg and starts the next leg of the route:
  - a When the boat comes within 0.025 nm of the waypoint.
  - b Or when the boat passes the waypoint.
  - c Or if the waypoint is skipped (see section 10-3-2).
- 5 When the boat has reached the final waypoint, or to stop the boat following the route at any time, cancel the route (see section 10-3-3).

## 3 Chart

The chart display is the most important of the TRACKER's displays, showing the chart, the boat's position and course, and navigation data.

### 3-1 Chart display

A typical chart display shows:

**Data display.** To turn the data off or on or to change what data is displayed, see section 3-1-8.

**The chart.** To change the types of information displayed, (see section 13-2).

Boat position  
(see section 3-1-1).

Boat track  
(see section 3-5).

Boat course and CDI lines  
(see Appendix C, CDI).

Boat is going to the waypoint called FISH06.

Distance and bearing of cursor from boat.

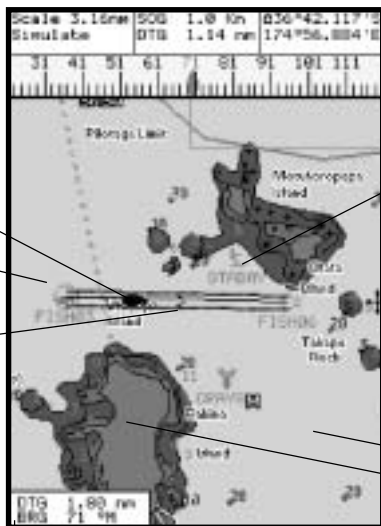

Compass display  
(see section 3-1-4).  
To turn the compass off or on, see section 3-1-8.

Typical waypoint  
(see section 9).

The cursor  
(see section 3-1-1).

Sea  
Land

Chart is in cursor mode, press **ESC** to return to centre on boat mode (see section 3-1-1).

#### 3-1-1 Chart modes

The Chart has two modes, centre on boat mode and cursor mode. These are explained below.

##### Centre on boat mode

To switch to centre on boat mode in the chart display, press **ESC**. The boat  is at the centre of the chart. As the boat moves through the water, the chart automatically scrolls to keep the boat in the centre of the chart. The cursor (see below) is turned off.

##### Cursor mode

The keys **▲**, **>**, **▼** and **<** are called cursor keys. To switch to cursor mode in the chart display, hold down a cursor key. The cursor  appears and moves away from the boat:

- Press the key which points in the direction that the cursor will move, for example press **▼** to move the cursor down.

- Press midway between two of the cursor keys to make the cursor move diagonally.
- Hold a cursor key down to make the cursor move continuously across the display.

In Cursor mode:

- The distance (+RNG) and bearing (+BRG) of the cursor from the boat are displayed at the bottom, left corner of the display.
- The chart does not scroll as the boat moves.
- If the cursor reaches the edge of the display, the chart will scroll.

For example, hold down **>** to move the cursor to the right side of the display and the chart will scroll to the left.

### 3-1-2 Latitude and longitude

Latitude and longitude can be displayed at the top of the chart. Normally the position is the boat's position, and the latitude has a boat symbol to show this:

|                 |   |
|-----------------|---|
| ↑ 36° 29.637' S | Latitude  |
| 175° 09.165' E  | Longitude   |
| Degrees         | Minutes, to 3 decimal places<br>(about 2 m (6 ft) resolution) |

If the cursor has been moved in the last ten seconds, then the position is the cursor's position, and the latitude has a cursor symbol to show this:

|                 |
|-----------------|
| + 36° 29.684' S |
| 175° 09.201' E  |

**⚠ Warning:** When reading the boat position, make sure the position is not the cursor position.

### 3-1-3 Chart scale

Press **+** to zoom in and display a smaller area of the chart in more detail. Press **-** to zoom out and display a bigger area in less detail.

The chart scale can be displayed (e.g. scale = 8 nm, see below). The scale is the vertical distance across the currently visible chart area. For example if the scale is 8 nm then a portion of chart eight nautical miles high is currently displayed.

### 3-1-4 The compass

A compass can be displayed at the top of the chart (see section 3-1-8).

When the boat is navigating to a point, the compass shows the bearing to the destination (BRG) in the middle and the boat's course over ground (COG), for example here BRG is 4° and COG is 12°:

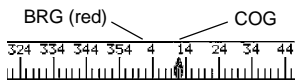

Otherwise the compass shows the boat's COG in the middle, for example here COG is 12°:

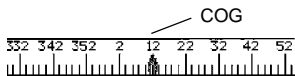

### 3-1-5 Chart symbols

The chart will show symbols, such as waypoints and chart symbols. When the cursor is placed over a symbol for at least two seconds, a data window appears at the bottom left of the display with information about the symbol.

### 3-1-6 Chart information

To see stored data about a point on the chart (for example, a chart symbol):

- 1 Move the cursor to that point on the chart.
- 2 Press **MENU** and select *Chart info*.
- 3 A menu of objects is displayed:
  - i Select an object to display.
  - ii Press **ESC** to return to the menu. Select other objects.
  - iii Finally, press **ESC** to return to the chart.

### 3-1-7 Find nearby services

To find and display nearby services:

- 1 To see services near the boat's position, press **ESC** to switch to centre on boat mode. To see services near a different point, move the cursor to that point on the chart.
- 2 Press **MENU** and select *Find*.
- 3 Select the type of service. There are three types of service:

**Ports**

A list of ports is displayed. Press **-** or **+** to display any other ports. Select the port to display. To search for a port:

- i Press **MENU** and select *Find*.
- ii Enter some or all of the letters of the port name. Press **ENT**.

#### Port services

- i Select the type of service to find.
- ii A list of places with this service are displayed. Select the place to display.

#### Tide stations

A list of tide stations is displayed. Select the station to display. The chart redraws with the tide station centred. To display a tide chart (see section 8) for the station:

- i Press **MENU** and select *Chart info*.
- ii Select *Tide height*.

### 3-1-8 Change the data display and compass display

Numeric data and a compass can be displayed at the top of the chart display. To change these:

- 1 Press **MENU** and select *Data header*.
- 2 To turn the data display off or on:
  - i Select *Data*.
  - ii Select *Off or On*.
- 3 To choose the size of the numbers:
  - i Select *Size*.
  - ii Select:

**Small:** displays three fields per line and up to four lines.

**Medium:** displays two fields per line and up to four lines.

**Large:** displays same amount of data as medium but with a larger font.

- 4 To change the data display:
  - i Select *Data setup*.
  - ii Change a data field:
    - a Press the cursor keys to highlight the field.
    - b Press **ENT** to display a menu of the data that can be shown in the field.
    - c Select the data to show in the field; select *None* to leave the field empty.

- iii Repeat the above step to set the other data fields. Press **ESC**.

 **Tip:** If less than four lines are used, the numeric data will take up less of the chart area.

- 5 To turn the compass display off or on:
  - i Select *Compass*.
  - ii Select *Off or On*.
- 6 Finally, press **ESC** to return to the chart display.

## 3-2 Distance and bearing calculator

The distance and bearing calculator can plot a course of one or several legs and to show the bearing and length of each leg, as well as the total distance along the course. The completed course can be converted into a route.

To use the distance and bearing calculator:

- 1 Press **ESC** until the chart display is displayed. Press **MENU** and select *Distance*.
- 2 Move the cursor to the start of the first leg. It does not matter if this point is a waypoint or not. Press **ENT**.
- 3 To add a leg to the course, move the cursor to the end of the leg. It does not matter if this point is a waypoint or not. The display shows the

bearing and length of the leg, as well as the total distance along the course. Press **ENT**.

- 4 To remove the last leg from the course, press **MENU** and select *Remove*.
- 5 Repeat the above two steps to enter the whole course.
- 6 To save the new course as a route, press **MENU** and select *Save*. This also saves any new points on the course as new waypoints, with default names. If necessary, edit the route later (see section 10-2-2) and edit any new waypoints later (see section 9-2-3).
- 7 Finally, press **ESC** to return to the chart display.

**Note:** See section 13-6 for *Log functions*.

## 3-3 Goto

Goto is a simple way of navigating straight to one point.

### To start the Goto

- 1 Choose the point to go to:
  - To go to a waypoint or to any point on the chart:
    - i Press **ESC** until the chart display is displayed.
    - ii Move the cursor to the destination.
    - iii Press **MENU** and select *Goto*.
  - To go to a waypoint from the waypoints display:
    - i Press **DISP** and select *Waypoints*.
    - ii Press **V** or **▲** to highlight the destination waypoint.
    - iii Press **MENU** and select *Goto*.

 **Warning:** Make sure the course does not pass over land or dangerous waters.

- 2 The TRACKER starts navigating to the destination (see section 2-7). The chart shows:
  - The destination point marked with a circle.
  - The boat's plotted course to the destination.
  - Two CDI lines, parallel to the boat's plotted course (see Appendix C, CDI).

### To cancel a Goto

- 1 Press **ESC** until the chart display is displayed.
- 2 Press **MENU** and select *Cancel goto*.

## 3-4 Projected course

If Projected course is turned on, then the TRACKER will display the projected position based on the course over ground (COG), speed and a specified time. To turn Projected course on and off and to set the time, see section 13-2.

Projected position  
Boat's projected course  
Boat position

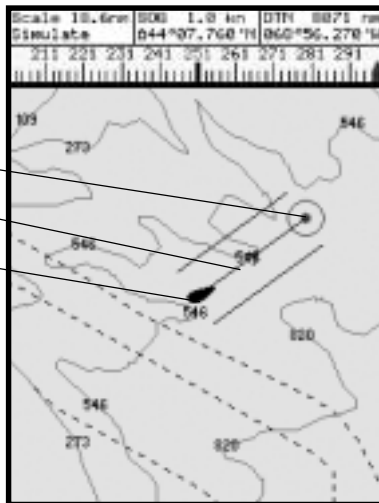

## 3-5 Tracks and tracking

Tracking records the boat's position to memory at regular intervals, which can be:

- Time intervals.
- Or distance intervals.

The track of where the boat has been can be displayed on the chart. The TRACKER can display one track while recording another.

To work with tracks, (see section 13-5).

The TRACKER can store five tracks:

- Track 1 can hold up to 2000 points and is intended to record the normal progress of the boat.
- Tracks 2, 3, 4 and 5 can hold up to 500 points each and are intended to record sections to be retraced accurately, for example entering a river mouth.

**Tip:** Record the tracks in good conditions. When recording is on and the track becomes full then recording continues and the oldest points in the track are deleted. The maximum length of a track depends on the selected track interval: a small interval will give a shorter, more detailed track and a long interval will give a longer, less detailed track, as shown in these examples:

### Time intervals

| Interval | Track 1    | Track 2, 3, 4 or 5 |
|----------|------------|--------------------|
| 1 sec    | 33 minutes | 8 minutes          |
| 10 sec   | 5.5 hours  | 1.4 hours          |
| 1 min    | 33 hours   | 8 hours            |

### Distance intervals

| Interval | Track 1 | Track 2, 3, 4 or 5 |
|----------|---------|--------------------|
| 0.01     | 20      | 5                  |
| 1        | 2,000   | 500                |
| 10       | 20,000  | 5,000              |

The track lengths are in the current distance units, for example nm.

## 4 Fuel display

To use the fuel display, the optional fuel kit must be installed and the fuel data set up (see section 13-4).

To go to the fuel display, press **DISP** and select *Fuel*.

### The fuel display shows:

**Used:** The total fuel used since it was reset to 0 by the Clear Used command (see section 13-4).

**Remaining:** The amount of fuel remaining in the fuel tank(s).

**Flow:** The fuel consumption. For twin engine installations, the fuel flow for each engine is shown separately. This is useful for checking that both engines are under the same load.

**Economy:** The distance travelled per unit of fuel used. The units are set by the units selected for speed and fuel. Adjust throttle and trim for best economy. The bigger the number the better the economy.

**Speed:** Boat speed over ground.

**Range:** The estimated distance that the boat is able to travel, based on fuel remaining and current fuel consumption.

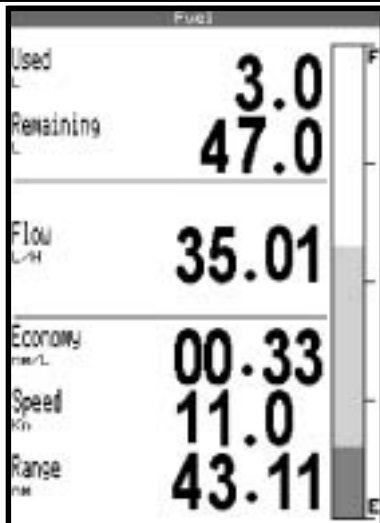

### ⚠ Warnings:

- **Fuel economy can change drastically depending on boat loading and sea conditions. Always carry adequate fuel for the journey plus a sufficient reserve.**
- **Each time fuel is added or removed use the fuel setup menu (see section 13-4) to record the fuel or else fuel remaining and the low fuel alarm will be meaningless!**

## 5 Data display

The data display has eight large numeric data fields, four lines with two fields per line.

To go to the data display, press **DISP** and select *Data*.

### Change what data is displayed

- 1 Press **MENU** and select *Data setup*.
- 2 Change a data field:
  - i Press the cursor keys to highlight the field.
  - ii Press **ENT** to display a menu of the data that can be shown in the field.
  - iii Select the data to show in the field; select *None* to leave the field empty.
- 3 Repeat the above step to change other fields.
- 4 Finally, press **ESC** to return to the data display.



## 6 Highway display

The highway display has a bird's eye view of the boat's course to a destination:

To go to the highway display, press **DISP** and select *Highway*.

**⚠ Warning:** The highway display does not show land, dangerous waters or chart symbols.

The highway display shows:

Six numeric data fields

To change what data is displayed, see below

Destination waypoint

Boat's plotted course to destination

CDI lines, parallel to the boat's plotted course (see Appendix C, CDI). The CDI lines are like a highway over the water where the boat will move.

Boat position is at the bottom, centre of the display  
CDI scale

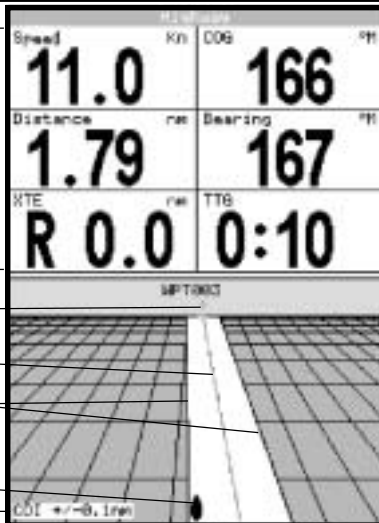

### Change the numeric data display

- 1 In the highway display, press **MENU** and select *Data setup*.
- 2 Change a data field:
  - i Press the cursor keys to highlight the field.
  - ii Press **ENT** to display a menu of the data that can be shown in the field.

- iii Select the data to show in the field; select *None* to leave the field empty.
- 3 Repeat the above step to change other fields.
  - 4 Finally, press **ESC** to return to the highway display.

## 7 Satellites

### GPS worldwide navigation

The US Government operates the GPS system. Twenty-four satellites orbit the earth and broadcast position and time signals. The positions of these satellites are constantly changing. The GPS receiver analyses the signals from the closest satellites and calculates exactly where it is on earth. This is called the GPS position.

The accuracy of the GPS position is typically better than 10 m (33 ft) for 95% of the time. A GPS antenna can receive signals from the GPS satellites when it is almost anywhere on earth.

### GPS antennas

The TRACKER must be used with the external GPS antenna supplied. The TRACKER has a sensitive 12-channel receiver built in, which tracks signals from all satellites visible above the horizon and uses measurements from all satellites more than 5° above the horizon to calculate the position.

### DGPS

A DGPS system uses correction signals to remove some of the errors in the GPS position. The TRACKER can use one of two types of DGPS system:

- **WAAS and EGNOS DGPS**

WAAS and EGNOS are two satellite based DGPS systems. The correction signals are broadcast by satellites and are received by the TRACKER's standard GPS antenna. The accuracy of the corrected GPS position is typically better than 5 m (16 ft) for 95% of the time.

WAAS covers all of the USA and most of Canada. EGNOS will cover most of Western Europe when it becomes operational about the end of 2003. To enable WAAS and EGNOS DGPS, (see section 13-3).

- Differential beacon DGPS**  
 Differential beacons are land based radio transmitters that broadcast correction signals that can be received by a special receiver on the boat. Differential beacons are usually only installed near ports and important waterways, and each beacon has a limited range. The accuracy of the corrected GPS position is typically better than 2 to 5 m (6 to 16 ft).

To use differential beacon DGPS, the TRACKER must be installed with an external DGPS antenna, such as the NAVMAN DGPS 1 (see section 15-3).

## Startup

Each time a GPS receiver is turned on, it normally takes about 50 seconds before it outputs the first position. Under some circumstances it will take up to two minutes or longer.

## 7-1 Satellite display

The satellite display has information about the GPS satellites and GPS position.

To go to the satellite display, press **DISP** and select *Satellite*.

When the TRACKER is turned on, the satellite display is shown automatically while the GPS antenna starts up.

### The satellite display shows:

Time and date from GPS satellites. Time is local time (UTC [GMT] plus local offset, see section 13-9)

HDOP: The error in the GPS position caused by satellite geometry. A low value indicates a more precise fix, a high value a less precise fix

Signal strengths of up to twelve visible GPS satellites. The higher the bar the stronger the signal

Status of GPS antenna, for example Acquiring, GPS fix, No GPS. If the unit is in Simulate mode it displays Simulate (see section 2-6)

Positions of visible GPS satellites:

- Outer circle is horizon
- Inner circle is 45° elevation
- Centre is directly above
- North is at top of display

If the boat is moving, COG is a line from centre

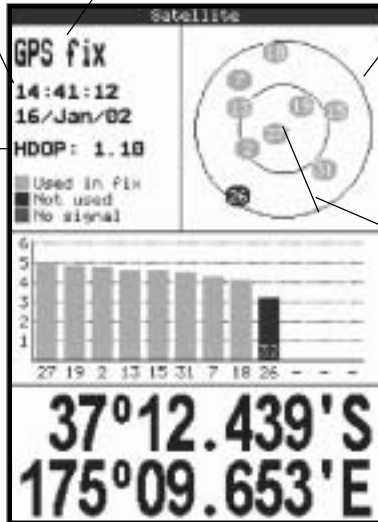

Boat position

## 8 Tides display

The tides display shows tide information at a tide station for the selected date.

To go to the tides display for the tide station nearest to the boat, press **DISP** and select *Tides*.

To go to the tides display for any tide station:

- 1 From the chart display, press **MENU** and select *Find*.
- 2 Select *Tide stations*.
- 3 A list of tide stations are displayed. Select the tide station to display. The chart redraws with the tide station centred.

4 Press **MENU** and select *Chart info*.

5 Select *Tide height*.

### Choosing the date of the tide chart

- 1 Press **MENU**.
- 2 Select *Today*, *Next day* or *Prev day*.

To choose a different date from these, select *Set date*, edit the date, press **ENT**.

The tides display shows data for the chosen date:

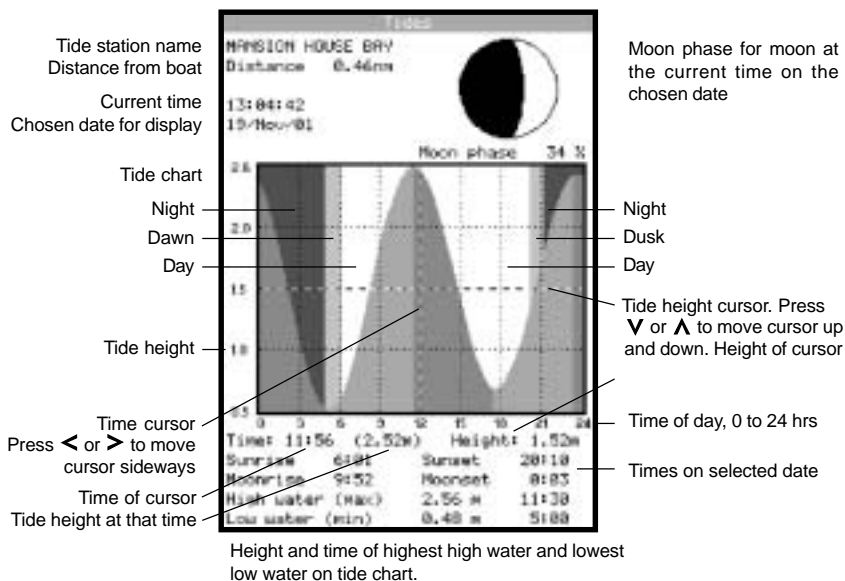

## 9 Waypoints

A waypoint is a position of interest that is saved by the TRACKER, for example a fishing spot or a point on a route. The TRACKER can have up to 3000 waypoints. A waypoint can be created, changed or deleted. A waypoint has:

- A name (up to eight characters).
- An icon showing what kind of waypoint it is. The available icons are:



- A position.
- A colour for the waypoint symbol and name on the chart.

- A type:

**Normal:** A normal waypoint can be navigated to or included in a route.

**Danger:** A danger waypoint is a point to avoid. If the boat comes within the danger radius of a danger waypoint the unit can sound an alarm (see section 13-6).

- A display option:

Controls how the waypoint is displayed when the *Waypoints* setup option is set to *Selected* (see section 13-2):

**Off:** The waypoint is not displayed.

**Icon:** The waypoint icon is displayed.

**I+N (Icon and Name):** The waypoint icon and name are displayed.

If there are many waypoints, use this feature to select which waypoints are displayed on the chart.

**Note:** The other choices for the “Waypoints” setup option are “Hide all” (no waypoints are displayed on the chart) and “Show all” (all the waypoints are displayed on the chart) (see section 13-2).

### 9-1 Waypoints display

To go to the waypoints display, press **DISP** and select *Waypoints* (see right).

The waypoints display is a list of the waypoints that have been entered, each with waypoint symbol, name, latitude and longitude, distance and bearing from the boat, type and display option.

Press **-** or **+** to display any other waypoints. To change how the waypoints list is displayed:

- 1 Press **MENU** and select *Sort by*.
- 2 Select how to display the list:
  - Name:** In alphabetical order by name.
  - Icon:** Grouped by icon type.
  - Distance:** In order of distance from the boat.

### 9-2 Managing waypoints

**Warning:** Do not create a navigation waypoint on land or in dangerous water.

#### 9-2-1 Creating a new waypoint

**Creating a new waypoint from any display**

Press **W**. A new waypoint is created at the boat position with the default name and data. To change the default data, (see section 9-2-3).

| Waypoints |             |              |           |         |      |      |
|-----------|-------------|--------------|-----------|---------|------|------|
| ▼Name     | Latitude    | Longitude    | DIST (nm) | Brg (°) | Disp | DLSP |
| X4PT001   | 35°45.698'N | 172°22.121'W | 8071      | 251     | No   | I+N  |
| X4PT002   | 28°10.810'S | 169°36.333'W | 7981      | 254     | No   | I+N  |
| X4PT003   | 27°42.918'S | 178°33.174'W | 7557      | 252     | No   | I+N  |
| X4PT004   | 33°16.876'S | 179°12.616'W | 7638      | 258     | No   | I+N  |
| X4PT005   | 35°45.698'N | 172°22.120'W | 8071      | 251     | No   | Icon |
| X4PT006   | 35°45.694'N | 172°22.120'W | 8071      | 251     | No   | Icon |
| X4PT007   | 35°45.684'N | 172°22.120'W | 8071      | 251     | No   | Icon |
| X4PT008   | 30°83.338'N | 074°54.863'W | 483.5     | 234     | No   | I+N  |

to Page up / down

## Creating and editing a new waypoint from the chart display

- 1 To create a waypoint at the boat position, press **ESC** to switch the chart to centre on boat mode (or press **■** see above).  
Or, to create a waypoint at a different point, move the cursor to that point on the chart.
- 2 Press **MENU** and select *New waypoint*.
- 3 A new waypoint, with the default name and data is created.
- 4 Change the waypoint data if necessary (see section 9-2-7). Select **Save**.

## Creating a new waypoint from the waypoints display

- 1 In the waypoints display, press **MENU** and select *Create*.
- 2 A new waypoint, with a default name and data, is created at the boat position.
- 3 Change the waypoint data if necessary (see section 9-2-7). Select **Save**.

**Note:** *Waypoints can also be created when a route is created (see section 10-2-1).*

## 9-2-2 Moving a waypoint

### Moving a waypoint from the chart display

- 1 In the chart display, move the cursor to the waypoint to move.
- 2 Press **MENU** and select *Move*.
- 3 Move the cursor to the new position and press **ENT**.

### Moving a waypoint from the waypoints display

To move a waypoint from the waypoints display, edit the waypoint (see section 9-2-3) and change the latitude and longitude.

## 9-2-3 Editing a waypoint

### Editing a waypoint from the chart display

- 1 In the chart display, move the cursor to the waypoint to edit.
- 2 Press **MENU** and select *Edit*.
- 3 Change the waypoint data (see section 9-2-7). Select **Save**.

### Editing a waypoint from the waypoints display

- 1 In the waypoints display, press **V** or **▲** to highlight the waypoint to edit. Press **MENU** and select *Edit*.
- 2 Change the waypoint data (see section 9-2-7). Select **Save**.

## 9-2-4 Displaying a waypoint on the chart

This goes to the chart display, and shows the selected waypoint at the centre of the display.

- 1 In the waypoints display, press **V** or **▲** to highlight the waypoint to display. Press **MENU** and select *Display*.

- 2 The TRACKER switches to the chart display, with the selected waypoint at the centre of the chart.

## 9-2-5 Deleting a waypoint

A waypoint can not be deleted if the boat is navigating to it or if the waypoint is used in more than one route. A waypoint that is used in one route can be deleted.

**▲ Warning when a waypoint is deleted from a route, check that the changed route does not cross land or dangerous waters.**

### Deleting a waypoint from the chart display

- 1 In the chart display, move the cursor to the waypoint to delete.
- 2 Press **MENU** and select *Delete*.
- 3 Select **Yes** to confirm.

### Deleting a waypoint from the waypoints display

- 1 In the waypoints display, press **V** or **▲** to highlight the waypoint to delete. Press **MENU** and select *Delete*.
- 2 Select **Yes** to confirm.

## 9-2-6 Deleting all waypoints

- 1 In the waypoints display and press **MENU** and select *Delete all*.
- 2 Select **Yes** to confirm.

## 9-2-7 Changing a waypoint's data

To change the waypoint data when it is displayed in a window:

- 1 Select the data to change.  
Press **ENT**.  
Use the cursor keys to change the data.  
Press **ENT**.
- 2 If necessary, repeat the above step to change other data.
- 3 Select **Save**.

## 9-2-8 Sort Waypoints

To change the waypoint data when it is displayed in a window:

- 1 In waypoint screen press **MENU**.
- 2 Select "Sort By".
- 3 Choose to sort by Icon, Name or Distance. As you change sort mode you will notice an arrow at each column heading move to indicate the selected method.
- 4 **Note:** *To fast scroll through complete screens of waypoints use the range ± key to "Page down" or "Page up".*

## 10 Routes

A route is a list of waypoints that the boat can navigate along. Routes can be created, changed and deleted.

The TRACKER can have up to 25 routes. Each route can have up to 50 waypoints.

A route can:

- Start and stop at the same waypoint .
- Include waypoints more than once.

### 10-1 Routes display

The routes display is a list of the routes that have been entered, each with route name, start waypoint, end waypoint, number of legs and total distance.

To go to the routes display, press **DISP** and select *Routes*.

Press **—** or **+** to display any other routes.

The TRACKER can navigate along a route in either direction. Waypoints on the route can be skipped.

Routes are a powerful feature when the TRACKER is connected to an autopilot, allowing the vessel to be automatically guided along the route.

**⚠ Warning: Make sure that routes do not cross land or dangerous water.**

| ROUTES  |                  |              |
|---------|------------------|--------------|
| Name    | Start<br>End     | Legs<br>Dist |
| ROUTE01 | 4PT001<br>4PT004 | 3<br>1304 nm |
|         |                  |              |

### 10-2 Managing routes

**⚠ Warning: After creating or changing a route, display the route on the chart and check that it does not cross land or dangerous water.**

#### 10-2-1 Creating a new route

##### A. Creating a new route from the chart display

While creating the route:

- Press **+** or **—** to change the range; scroll the chart by moving the cursor to the edge of the chart.
- A data box at the top, left of the display shows the route name and total distance. If the cursor is near a leg, it shows the length and bearing of the leg as well.
- The legs of a route must start and end at waypoints. If a leg does not start or end at an existing waypoint then a new waypoint will be created automatically (to change the new waypoint data, see section 9-2-7).

- 1 In the chart display, press **MENU** and select *New route*.
- 2 The route is given a default name:
  - i Change the name if necessary.
  - ii Select *Ok*.
- 3 To enter the first leg of the route:
  - i Move the cursor to the start of the route and press **ENT**.
  - ii Move the cursor to the end of the first leg and press **ENT**.
- 4 To add a waypoint at the end of the route:
  - i Press **ENT**.

- ii Move the cursor to where the new route waypoint will be.
  - iii Press **ENT**.
- 5 To insert a waypoint in the route:
  - i Move the cursor to the chosen leg to insert the waypoint.
  - ii Press **MENU** and select *Insert*.
  - iii Move the cursor to where the new route waypoint will be.
  - iv Press **ENT**.
- 6 To move a waypoint in the route:
  - i Move the cursor to the waypoint to move.
  - ii Press **MENU** and select *Move*.
  - iii Move the cursor to where the waypoint will be.
  - iv Press **ENT**.
- 7 To remove a waypoint from the route:
  - i Move the cursor to the waypoint to remove from the route.
  - ii Press **MENU** and select *Remove*. The waypoint is removed from the route, but the waypoint is not deleted.
- 8 Repeat this process until the route is finished. Review the route and check that the route does not cross land or dangerous water. Then press **ESC**.  
Or, to delete the route that is being created:
  - i Press **MENU** and select *Delete*.
  - ii Select *Yes* to confirm.

**Tip:** The distance and bearing calculator can also be used to enter a course and save it as a route (see section 3-2).

## B. Creating a new route from the routes display

- 1 In the routes display, press **MENU** and select *Create*.
- 2 A new route, with a default name and no waypoints, is displayed.
- 3 To change the route name:
  - i Select the route name at the top of the display and press **ENT**.
  - ii Change the name if necessary.
  - iii Press **ENT**.
- 4 To insert a waypoint in the route:
  - i Select where the waypoint will be:
    - To insert the first waypoint in a new route, select Leg 1.
    - To insert a waypoint at the end of the route, select the unused leg at the end of the list of waypoints.
    - Otherwise, select the waypoint to insert the new waypoint in front of.
  - ii Press **ENT**. A list of waypoints is displayed. Select the waypoint to use.

As waypoints are inserted, the distance and bearing of each leg is shown automatically. If the route has more waypoints than will fit on the display, press **V** or **A** to see them.
- 5 To remove a waypoint from the route:
  - i Select the waypoint to remove.
  - ii Press **MENU** and select *Remove*.
- 6 Repeat this process until the route is finished.
- 7 Press **ESC**.
- 8 Display the route on the chart (see section 10-2-3) and check that the route does not cross land or dangerous water.

## 10-3 Navigating a route

### 10-3-1 Starting a route

To start the boat navigating along a route:

- 1 In the routes display, press **V** or **A** to highlight the route to use. Press **MENU** and select *Start*.
- 2 The TRACKER asks for the direction to traverse the route.

Select *Forward* (the order the route was created) or *Reverse*.
- 3 It displays a chart with the route marked and starts navigating from the start of the route.

### 10-2-2 Editing a route

#### Editing a route from the chart

- 1 In the routes display, select the route to edit. Press **MENU** and select *Edit on chart*.
- 2 The selected route is displayed on the chart, with a circle around the first waypoint.
- 3 Edit the route as described in section 10-2-1 A, starting at step 4.

#### Editing a route from the routes display

- 1 In the routes display, press **V** or **A** to highlight the route to edit. Press **MENU** and select *Edit*.
- 2 The selected route is displayed: the route name and a list of the waypoints.
- 3 Edit the route as described in section 10-2-1 B, starting at step 3.

### 10-2-3 Displaying a route on the chart

#### To view the selected route at the centre of the display

- 1 In the routes display, press **V** or **A** to highlight the route to display. Press **MENU** and select *Display*.
- 2 It returns to the chart display, with the selected route displayed.

### 10-2-4 Deleting a route

- 1 In the routes display, press **V** or **A** to highlight the route to delete. Press **MENU** and select *Delete*.
- 2 Select *Yes* to confirm.

### 10-2-5 Deleting all routes

- 1 In the routes display, press **MENU** and select *Delete all*.
- 2 Select *Yes* to confirm.

### 10-3-2 Skipping a waypoint in a route

To skip a waypoint when the boat is navigating along a route:

In the chart display, press **MENU** and select *Skip*.

The TRACKER starts navigating straight towards the next waypoint on the route.

**⚠ Warning: Skipping a waypoint with the autopilot on might result in a sudden course change.**

### 10-3-3 Cancelling a route

To stop the boat navigating along a route:

- In the chart display, press **MENU** and select *Cancel route*.

## 11 User card display

A C-MAP™ user card is an optional plug-in card that can store data files (see section 1-2). There are three types of files: waypoints, routes or a track.

To go to the user card display, press **DISP** and select *User card*.

**Note:** *The older 5 volt cards are not supported.*

The user card display has:

### File list

A list of the files on any user card in the TRACKER.

Press **-** or **+** to display other files.

### Waypts, Routes

The number of waypoints and routes currently in the TRACKER.

### Track 1 to Track 5

The number of points in tracks 1 to 5 currently in the TRACKER.

### Note:

- To save TRACKER data onto the user card, use the *Save* command (see below).
- Data stored on the user card and shown on the file list is not available to be used by the TRACKER until loaded into the TRACKER with the *LOAD* command (see below).

## Saving data to the user card

This saves all the TRACKER's waypoints, all the TRACKER's routes or one of the TRACKER's tracks to one file on the user card.

- 1 Press **MENU** and select *Save*.
- 2 Select *Waypts, Routes or Tracks*.
- 3 For *Tracks*, select the track number to save.
- 4 The new file is created. Change the name if required. The new file appears in the file list.

## Loading data from the user card to the TRACKER

This loads one file from the user card to the TRACKER:

- A waypoints file: The new waypoints are added to any existing waypoints in the TRACKER. If a new waypoint has the same name as an existing waypoint but has different data, the TRACKER displays both waypoints. Select:
  - Skip:** Do not load the new waypoint.
  - Replace:** Load the new waypoint and replace the existing one.
  - Skip all:** Do not load any new waypoints which have the same names as existing waypoints.
  - Rplc. all:** Load all new waypoints which have the same names as existing waypoints; the new waypoints replace the existing waypoints.

| User card |        |           |          |
|-----------|--------|-----------|----------|
| File      | Type   | Date      | Time     |
| FILE01    | Waypts | 01/Jan/88 | 00:00:00 |
| FILE02    | Routes | 03/Sep/81 | 21:52:00 |
| FILE03    | Tracks | 01/Jan/88 | 00:00:00 |
| FILE04    | Waypts | 01/Jan/88 | 00:00:00 |
| FILE05    | Tracks | 28/Sep/81 | 15:44:00 |
| FILE06    | Tracks | 28/Sep/81 | 16:36:00 |
| FILE07    | Tracks | 28/Sep/81 | 16:37:00 |
| FILE08    | Tracks | 26/Nov/88 | 08:01:00 |

| In memory |     |          |    |
|-----------|-----|----------|----|
|           |     | Track 2: | 28 |
| Waypts:   | 15  | Track 3: | 75 |
| Routes:   | 2   | Track 4: | 16 |
| Track 1:  | 206 | Track 5: | 28 |

- A routes file: The new routes are added to any existing routes in the TRACKER. If a new route has the same name as an existing route but has different data then the TRACKER asks which route to keep.
- A track file: The new track will replace the existing track in the TRACKER.

To load a file to the TRACKER:

- 1 Select the file to load.
- 2 Press **MENU** and select *Load*.

## Deleting a file from the user card

- 1 Select the file to delete.
- 2 Press **MENU** and select *Delete*.
- 3 Select *Yes* to confirm.

## Reading the file information

This reads the file names from the user card and displays them. Reading does not load any file data into the TRACKER.

- 1 Press **MENU** and select *Card*.
- 2 Select *Read*.

## Formatting the user card

Formatting prepares a user card for use. Format the card if there is an error message saying that the card is not formatted. Any data files on the card are deleted.

- 1 Press **MENU** and select *Card*.
- 2 Select *Format*.
- 3 Select *Yes* to confirm.

## Sorting the file names

This sorts the displayed file names.

- 1 Press **MENU** and select *Sort*.
- 2 Select sort by *Name, Type or Time*.

## 12 About display

To go to the about display, press **DISP** and select *About*.

The about display shows:

- The software version and date.
- The world chart version.
- Any card fitted.
- The number of waypoints, routes and tracks in the TRACKER.
- Wiring information for the TRACKER connectors.

In the unlikely event of having to contact a NAVMAN dealer for service, quote the software version number and date.

| About                     |                      |            |
|---------------------------|----------------------|------------|
| Tracker 5600              |                      |            |
| Copyright 2002 Navman NZ  |                      |            |
| Software 1.3.0 22/05/2002 |                      |            |
| Boot                      | 1.1.2                | 22/05/2002 |
| Bios                      | 1.0.3                | 04/03/2002 |
| Kernel                    | 1.3.0                | 22/05/2002 |
| NTSL                      | 4.1.0                | 06/02/2002 |
| File system               | 1.1.11               | 09/05/2001 |
| GPS                       | 2.1.226.2000         | 18/01/2002 |
| FPGA                      | 65                   |            |
| World chart: 1.30         |                      |            |
| Card: No card             |                      |            |
| Waypoints                 | 3000                 | 30 Used    |
| Routes                    | 25                   | 4 Used     |
| Tracks                    | 5                    | 1 Used     |
| Power/cables cable        |                      |            |
| 1 Black                   | Ground               |            |
| 2 Brown                   | +9V out              |            |
| 3 White                   | Autopilot out        |            |
| 4 Blue                    | Nav-Bus- / NHER 2 in |            |
| 5 Red                     | +13.8V in            |            |
| 6 Orange                  | Nav-Bus+             |            |
| 7 Yellow                  | Auto power           |            |
| 8 Green                   | Ext Alarm            |            |
| Fuel cable                |                      |            |
| 1 Black                   | Ground               |            |
| 3 White                   | NHER 1 in            |            |

## 13 Setup menu

The TRACKER has a number of advanced navigation features which are set up through the setup menu. We recommend that you become familiar with the operation of the unit using the

default settings before making any changes to the data in these menus.

To display the setup menu, press **MENU** until the setup menu is displayed.

### 13-1 System setup

#### Language

Select the language for the displays. The options are English, Italian, French, German, Spanish, Dutch, Swedish, Portuguese, Finnish and Greek.

#### Colours

Select the colour scheme for the LCD display. The options are:

##### **Normal**

**Sunlight.** Brighter colours, more visible in sunlight.

**Night.** Reversed colours for night, to preserve night vision.

**Paper.** Simulates the colours of a paper chart.

#### Keybeep

Enable or disable the beep when a key is pressed.

#### Factory reset

Resets all the TRACKER setup menu data back to the factory default settings as shown on the setup menu map. Any waypoints, routes or tracks are not deleted.

After the reset, the TRACKER displays an installation menu of setup data:

- 1 Select the language to use.
- 2 Change the setup data if necessary:
  - i Select the data item to change.
  - ii Use the cursor keys to change the data.
  - iii Press **ENT**.
- 3 When the setup data is correct, press **ESC**.

## Setup menu map, with factory default settings in brackets

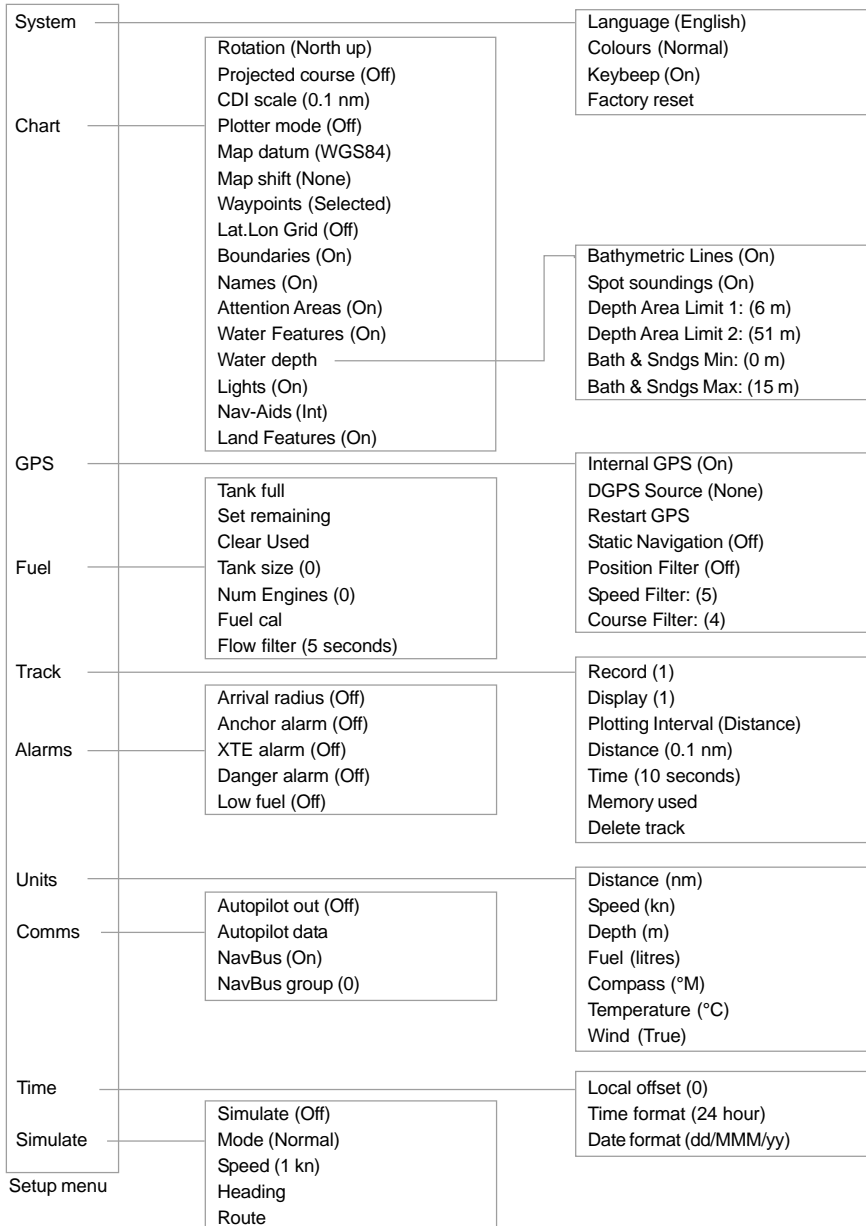

## 13-2 Chart setup

### Rotation

The options for chart rotation are:

**North up:** North is always at the top of the chart display.

**Track up:** The chart is rotated so that the boat direction is to the top of the display. This option is useful for navigating narrow harbours or rivers. The TRACKER asks for a course deviation; this is how much the boat direction needs to change to make the chart redraw.

 **Tip:** If the chart redraws too frequently, increase the course deviation setting.

**Course up:** This option is only available if the boat is navigating to a destination. The chart is rotated so that the plotted course to the destination is vertical.

### Projected course

The TRACKER can estimate the course after a given time, based on the current speed and heading (see section 3-4). The options are 2 minutes, 10 minutes, 30 minutes, 1 hour, 2 hours or Off.

### CDI Scale

The CDI Scale is described in Appendix C, CDI. The options are 0.05, 0.1, 0.2, 0.5, 1.0, 2.0, 4.0 and 10.0 distance units.

### Plotter mode

Occasionally it is desirable to use a chart scale which is not available on a chart card. Examples are:

- To zoom in to a small scale to track very small boat movements.
- If there is no detailed chart for an area, for example when crossing an ocean.

If *Plotter mode* is *On*, then if the chart zooms to a scale which is not available, the TRACKER will enter plotter mode and will only display the boat position and track (if enabled). Chart and map information will no longer be displayed and the display is white with black crosshatch lines.

For normal use, turn *Plotter mode* to *Off*.

### Map datum and map shift

Satellite derived positions on the TRACKER are based on a worldwide reference (datum) known as WGS84. Most paper charts are based on WGS84. However, some paper charts are not based on WGS84, which results in an offset between a position on the TRACKER and the same position plotted on the paper chart.

To match the TRACKER's positions with a local chart that is not based on WGS84:

- Either select *Map datum* and select the datum for the local chart. See Appendix A for a list of the available datums. WGS84 is the default datum, and the datum most commonly used on paper charts.
- Or, if the correct datum is not available, retain the WGS84 datum and apply a map shift (see below).

#### Map shift

Map shift is a correction applied to the TRACKER's positions so that they match a chart's positions.

 **Warning: Map shift is for eliminating minor offsets. It should not be used if the correct datum is available. Use map shift with caution: incorrect application will cause incorrect boat positions.**

#### Set map shift

- 1 Move the boat to a known point on the chart, for example a marina berth.
- 2 In the Chart setup menu, select *Map shift*.
- 3 Move the cursor to the position on the chart where the boat actually is.
- 4 Press **ENT** to set the new map shift. The boat will now be displayed at its actual location.

#### Clear map shift

Clearing the map shift removes any map shift from the TRACKER's positions.

- 1 In the Chart setup menu, select *Map shift*.
- 2 Press **MENU** and select *Clear*.

### Waypoints

Controls how waypoints are displayed on the chart. The options are:

**Hide all:** No waypoints are displayed.

**Show all:** All waypoints are displayed.

**Selected:** Waypoints with their display option set to *Icon* or *I+N* (*Icon* and *Name*) are displayed (see section 9).

### Chart display options

The other chart setup options allow an extensive range of chart card features to be shown. Configure the most useful display format.

**Note:**

#### Bathymetric Lines and soundings

*Chart cards contain a large amount of spot sounding and depth contour data. This can be selectively displayed by turning Bathymetric Lines and Spot Soundings on, then selecting the range to display with Bath and Sndgs Min and Max.*

#### Attention Areas

*Areas of importance, such as restricted anchorages and shallow areas, are highlighted as Attention Areas.*

The options are:

**On:** displays attention area boundaries and information icons .

**Off:** does not display attention area boundaries or information icons .

**Note:** In some early chart cards the information icons  are inactive.

### Depth area limits

The depth area limits control the chart water colours

for different depths. There are three water colours:

#### Surface to Depth area limit 1:

Shallow water colour.

#### Depth area limit 1 to Depth area limit 2:

Medium water colour.

#### Below Depth area limit 2:

Deep water colour.

The actual water colours depend on the LCD colour scheme in use (see section 13-1).

## 13-3 GPS setup

### GPS Source

Disable or enable the TRACKER's internal GPS receiver. Disable this if a non-standard GPS antenna that sends NMEA data is installed.

### DGPS Source

Enables or disables the satellite based DGPS correction (see section 7). The options are None or WAAS/EGNOS. Do not enable WAAS/EGNOS outside their coverage areas or the accuracy of the position might be degraded.

WAAS covers all of the USA and most of Canada. EGNOS will cover most of Western Europe when it becomes operational about the end of 2003.

### Restart GPS

Restarts the internal GPS receiver for servicing or troubleshooting. The GPS receiver takes up to three minutes to restart. The satellite display shows the status of the GPS receiver (see section 7).

### Static Navigation

The displayed speed and course become erratic when the boat stops. Turn Static navigation On to display speed and course as zero when the boat is stopped.

### Position, Speed and Course Filter

Waves and wind cause the boat position, speed and course to fluctuate slightly. To give stable readings, the TRACKER calculates these values by taking several measurements and averaging them.

- A lower value averages measurements over a shorter period of time. This gives the most accurate value but has the most fluctuations.
- A higher value averages measurements over a longer period of time. This gives the most stable value but will ignore some true speed changes.

Set the Position, Speed and Course filters to the lowest values which give stable readings. The range of each filter is 1 to 60 seconds or Off (0).

## 13-4 Fuel Setup

To use these fuel features first purchase and install the optional single or twin engine fuel kit.

Whenever fuel is added or removed from the tank, use this menu:

- If the tank is filled, select Tank Full.
- If the tank is partly filled or fuel removed:
  - 1 Before adding or removing the fuel, go to the fuel display and note how much fuel is in the tank.
  - 2 Note how much fuel is added or removed.
  - 3 Calculate how much fuel is now in the tank by adding or subtracting the two figures.
  - 4 Select this menu and enter how much fuel is now in the tank in Set Remaining.

**Warning:** Do this each time fuel is added or removed or else fuel remaining and the low fuel alarm will be meaningless!

### Tank Full

Select *Tank full* each time the tank is filled full.

When asked for confirmation, Select Yes.

### Set Remaining

Enter the amount of fuel now in the tank after it has been partly filled or fuel has been removed.

### Clear Used

Select *Clear Used* to set Used (the amount of fuel used) to zero. Do this to restart measuring the amount of fuel used.

When asked for confirmation, Select Yes.

### Tank Size

Enter the capacity of the fuel tank.

### Num Engines

Set the number of engines to 0, 1 or 2.

If 0 is selected the fuel features are turned off.

## Fuel Cal

Without calibration the error in fuel measurements can be up to  $\pm 10\%$ . Calibration can reduce the error substantially. For twin engine installations calibration of each transducer is required.

Calibrating the fuel transducer requires accurate measurement of the fuel used. This is easiest with a small portable tank. It should be noted that due to air pockets, it is very difficult to fill underfloor tanks to the same level twice. At least 15 litres (4 US gallons) should be used to ensure an accurate calibration. (The more fuel used, the more accurate the calibration will be.) Each transducer in a twin engine installation must be calibrated separately. This may be done at the same time with two portable tanks, or at different times using one tank at a time.

The procedure is:

- 1 Select *Clear Used* to set Used to zero.
- 2 Connect the measurement tank(s) to the engine(s) via the fuel transducer(s).
- 3 Run the engine(s) at normal cruising speed until at least 15 litres (4 US gallons) is indicated (30 litres [8 US gallons] for twin engines).

- 4 Check the actual amount of fuel used per engine. The easiest way to do this is to refill the tank(s) to the original level(s) and record the value(s) shown on the fuel dispenser.
- 5 Select *Fuel Cal*. The amount of fuel that the TRACKER has measured is displayed. Change the number to the actual fuel amount used. (Repeat for the other engine in a twin engine installation).

## Flow Filter

Normally engines do not draw fuel from the tank at a steady rate. To give a stable fuel flow reading, the TRACKER calculates the flow values by taking several measurements and averaging them. The flow filter sets the period over which the fuel flow is averaged, and can be set from 1 to 180 seconds or Off.

Set the flow filter to the lowest value which give a stable flow. Usually a value of 10 to 15 seconds will give a satisfactory result for carburettor engines. Fuel injected engines may require a larger value.

This setting affects the Flow rate and Economy displays. It does not affect the fuel used measurement.

## 13-5 Track setup

Tracking records and displays the boat's course on the chart (see section 3-5).

### Record

**Off:** The TRACKER stops recording a track.

**1 to 5** (select a track number): The TRACKER starts recording the boat's course into the selected track.

### Display

**Off:** No track is shown on the chart.

**1 to 5** (select a track number): The selected track is shown on the chart.

### Plotting Interval

The options are *Distance* or *Time*.

### Distance

Select the distance plotting interval: 0.01, 0.05, 0.1, 0.5, 1.0, 2.0, 5.0 or 10.0 distance units.

### Time

Select the time plotting interval: 1, 5, 10 or 30 seconds or 1 minute.

### Memory used

The percentage of memory used in the track being recorded.

**Tip:** Use the user card display to check the number of points recorded in each track (see section 11).

### Delete track

- 1 Select the track number to delete (1 to 5).
- 2 Select Yes to confirm.

The data in the selected track is deleted.

## 13-6 Trip log(s)

For displaying the trip log(s) on the data header, see section 3-1-8.

Press MENU twice, then select Trip to display the trip.

Selecting **Reset trip dist** or **Reset total dist** then pressing ENTER resets each to zero.

| Trip             |         |
|------------------|---------|
| Reset trip dist  |         |
| Reset total dist |         |
| -----            |         |
| Trip dist        | 9.54 nm |
| Total dist       | 9.54 nm |

## 13-7 Alarms setup

For alarm operation, see section 2-5. To turn off an alarm which is sounding, press **ESC**.

### Arrival radius alarm

When the arrival radius alarm is enabled, an alarm will sound:

- When the boat is going to a point and the boat comes within the arrival radius of the destination
  - Or when the boat is navigating a route and the boat comes within the arrival radius of a waypoint in the route.
- To enable the alarm, enter an arrival radius (up to 9.99 distance units).
  - To disable the alarm, set the arrival radius to *Off*(0).

### Anchor alarm

When the anchor alarm is enabled, an alarm will sound when the boat moves by more than the anchor alarm distance.

- To enable the alarm, enter an anchor alarm distance (up to 9.99 distance units). The TRACKER saves the current boat position.
- To disable the alarm, set the anchor alarm to *Off*(0).

The minimum usable setting of the alarm is determined by the accuracy of the global positioning system, typically within 10 m (33 ft).

## 13-8 Units setup

### Distance units

Options are nm (nautical miles), mi (statute miles) or km (kilometres).

### Speed units

Options are kn (knots), mph (miles per hour) or kph (kilometres per hour).

### Depth units

Options are ft (feet), fm (fathoms) or m (metres).

### Fuel units

Options are litres, US gal (US gallons) or Imp gal (Imperial gallons).

## 13-9 Comms setup

### Autopilot out

Disable or enable the NMEA output to an autopilot or other instrument.

### Autopilot data

Displays a list of the NMEA sentences that can be sent to an autopilot. Turn each Off or On as required.

**⚠ Warning:** Do not rely on the anchor alarm as the only anchor watch.

### XTE alarm

When the XTE alarm is enabled, an alarm will sound when the boat is navigating to a point and the distance from the boat to the plotted course (XTE) is more than CDI (Course Deviation Indicator) scale (see Appendix C, CDI).

- To enable the alarm, set the XTE alarm to *On*.
- To disable the alarm, set the XTE alarm to *Off*.

### Danger alarm

When the danger alarm is enabled, an alarm will sound when the boat comes within this distance of a danger waypoint.

- To enable the alarm, enter an danger alarm distance (up to 9.99 distance units).
- To disable the alarm, set the danger alarm to *Off*(0).

### Low fuel alarm

When the low fuel alarm is enabled, an alarm will sound when the fuel remaining in the tank is less than the low fuel value.

- To enable the alarm, enter a low fuel value.
- To disable the alarm, set the low fuel value to *Off*.

### Compass

The options are °T (True north) or °M (Magnetic north).

### Temperature (optional)

The options for water temperature are °C or °F.

### Wind (optional)

The options for wind speed and direction are True or App (Apparent). **Note:** *that the units for wind speed are the speed units.*

### NavBus

**Off:** NavBus is disabled. One of the NavBus connector pins becomes a NMEA input line (see sections 14 and 15-3).

**On:** NavBus is enabled.

### NavBus group

Enter the NavBus backlight group number (the range is 0 to 4, see section 14).

## 13-10 Time setup

### Local offset

The difference between local time and UTC (GMT). Change local offset when daylight saving time starts and ends. The range is 0 to  $\pm$  13 hours, in 30 minute steps.

### Time format

The options are 24 hour or 12 hour.

### Date format

The options are dd/MMM/yy, MMM/dd/yy, dd/MM/yy or MM/dd/yy.

## 13-11 Simulate setup

Simulate mode is a way of becoming familiar with the TRACKER (see section 2-6).

**⚠ Warning:** Never have simulate mode on when the TRACKER is navigating on the water.

### Simulate

Turn simulate mode *Off* or *On*.

Press **MENU** and select *simulate*.

Select *On* or *Off*.

### Mode

There are two choices for *Mode*:

#### Normal

Simulates the boat moving from the selected start point (see step 1 above) at the given speed and heading. The options are:

**Speed:** The simulated boat speed to use.

**Heading:** The simulated bearing for the boat to follow.

 **Tip:** To calculate a heading, use the cursor (see section 3-1-1).

 **Tip:** As the boat moves, vary Heading to simulate the boat moving off course.

### Demo

Simulates the boat moving along a route at a given speed. When it reaches one end it retraces the route in the other direction. Before setting this mode enter at least one route (see section 10-2-1). The options are:

**Speed:** The simulated boat speed to use.

**Route:** The route to follow.

### To turn simulate mode on from this menu:

- 1 If turning Normal mode on, go to the chart display. To start the simulation from the boat position, press **ESC** to switch to centre on boat mode. To start the simulation from a different point, move the cursor to that point on the chart.
- 2 In the Simulate setup menu, select *Simulate* and turn it on.
- 3 Select *Mode* and set it to *Normal* or *Demo*.
- 4 Select and enter the other data required for simulate:
  - Normal requires *Speed* and *Heading*.
  - Demo requires *Speed* and *Route*.

## 14 Systems of several instruments

Several NAVMAN instruments can be connected together to share data. There are two ways of connecting instruments together, NavBus or NMEA.

### NavBus

NavBus is a NAVMAN proprietary system that allows systems of multiple instruments to be built using a single set of transducers. When instruments are connected by NavBus:

- If the units, alarms or calibration are changed in one instrument, then the values will automatically change in all other instruments of the same type.
- Each instrument can be assigned to a group of instruments (see section 13-8). If the backlight is changed in an instrument in group 1, 2, 3 or 4 then the backlight will automatically change in the other instruments in the same group.

If the backlight is changed in an instrument in group 0 then no other instruments are affected.

- If an alarm sounds, mute it by clearing the alarm on any instrument which can display that alarm.

### NavBus and the TRACKER

- The TRACKER can display data (e.g. depth, speed, log and wind) from NAVMAN's 3100 series instruments when connected.

### NMEA

NMEA is an industry standard, but is not as flexible as NavBus as it requires dedicated connections between instruments. The TRACKER can:

- Receive and display depth data.
- Receive data from a GPS antenna.
- Send GPS position and other navigation data to an autopilot or other instrument.

## 15 Installation

Correct installation is critical to the performance of the unit. There are two components to install, the TRACKER and a GPS antenna. In addition, install the optional fuel kit to use the TRACKER as a fuel computer.

The TRACKER can:

- Drive external beepers or lights for the alarm.
- Send and receive data from other NAVMAN instruments connected via NavBus. The backlight setting is shared (see section 14).
- Send NMEA data to an autopilot or other instrument.
- Accept and display NMEA data from a depth sounder.

The TRACKER can be wired for auto power so that it automatically turns on and off with the boat power and can not be turned on or off manually. Wire auto power if the fuel option is installed, so that the TRACKER records all the fuel that is used (see section 15-3).

It is vital to read the entire installation section of this manual and the documentation that comes with the antenna and any other units before starting installation.

### 15-1 What comes with the TRACKER

#### Standard configuration

- TRACKER display unit, with a holder for plug-in cards and blanking cap for fuel connector.
- Dust cover for display unit.
- Mounting bracket.
- Flush mount kit.
- Power/data cable.
- NAVMAN 1300 GPS antenna.
- Warranty card.
- This Installation and Operation manual.
- Screws.



### 15-2 Options and accessories

- C-MAP™ chart cards.
- C-MAP™ user cards (3 V) for storing data.  
**Note:** *The older 5 volt cards are not supported.*
- Fuel kit for single or twin petrol/gasoline engines.  
If a fuel kit is installed, wire auto power on so that the TRACKER is on all the time the engine is on and no fuel consumption is missed (see section 15-3).
- Beepers with built-in drivers or lights. The TRACKER output is switched to ground, 30 V DC and 200 mA maximum. If the beepers and lights require more than 200 mA, fit a relay.
- 5 m (16 ft) extension cable for NAVMAN 1300 GPS antenna.
- Second station kit. Allows a bracket mounted TRACKER to be used at another place in the boat (contains second mounting bracket and cables).
- NAVMAN's REPEAT 3100.
- NAVMAN carry bag.

## 15-3 Installation

**⚠ Warning:** Ensure that any cut holes will not weaken the boat. If in doubt, consult a qualified boat builder or marine engineer.

### Display unit

- 1 Find a suitable location for the display unit:  
There are two mounting arrangements:  
**Flush mounting** requires a solid panel with access behind for wiring and mounting screws.  
**Bracket mounting** requires a panel for mounting the bracket. The bracket can be rotated and tilted.

Choose a location that is easily seen and not exposed to the direct sun or water. If possible, mount the display unit in front of the navigator or to the left of the navigator because the LCD display is more readable from these positions. Keep the unit away from any source of electrical signals or noise.

- 2 For flush mounting:
  - i Cut a hole in the bulkhead for the display unit using the flush mount template.
  - ii Drill four holes for the mounting studs using the flush mount template.
  - iii Screw the four studs into the brass inserts in the back of the display unit.
  - iv Sit the display unit in place and fit the washers and nuts to the studs.
- For bracket mounting:
  - i Hold the bracket in place and mark the screw holes.
  - ii Drill the screw holes and screw the bracket in place with the screws provided. Do not overtighten the screws or the display unit might not rotate.  
Do not fit the display unit yet.

### GPS antenna

- 1 Find a suitable location for the antenna:
  - Mount the antenna with a good view of the sky and horizon. The view should not be blocked by large parts of the superstructure. The unit can be under glass, perspex, fibreglass or fabric, but not under metal or wood.

- Mount the antenna away from any source of electrical signals or noise. Do not mount the antenna within 2 m (6 ft) of a radio transmitter antenna or within 0.5 m (20") of the plane of a radar antenna.
- Do not fit the antenna too high, such as up a mast, or rocking will cause errors in speed and bearing.
- Do not mount the antenna where it can be used as a hand hold, where it will interfere with the operation of the boat or where it might be submerged.
- The maximum antenna cable length is 15 m (49 ft).

If a location might not be suitable, follow the installation instructions below but mount the antenna and antenna cable temporarily, without drilling any fixing holes. If the system does not work properly, change the antenna location until it works properly. Then install the antenna and cable permanently.

- 2 Fit antenna in place.
- 3 Run the cable between the antenna and the display unit:
  - Keep the cable away from sources of electrical signals or noise.
  - Do not cut the antenna cable; if necessary, fit one 5 m (16 ft) extension cable.
  - Do not crush or pinch the antenna cable.
  - Secure the cable at regular intervals.

### Optional fuel kit

Fit the fuel kit following the instructions that come with the kit.

### Installation of a DGPS antenna

In areas where satellite differential (WAAS/EGNOS) is not available an optional combined GPS/DGPS antenna may be connected for enhanced accuracy when in range of conventional land based differential beacons. Please contact the nearest NAVMAN dealer for further information.

## Power/data cable for display unit

Wire the cable as shown on the next page.

### Note:

- *The unit requires 12 V DC power. This power supply must be protected with a fuse or circuit breaker of between 2 and 3 A. If it does not have this, fit a 2 A fuse in the power supply line.*
- *To enable auto power (see section 2-1), connect the yellow Power/data cable wire to the positive power supply as shown.  
To disable auto power, leave the wire disconnected; make sure it can not touch any other conductor.*
- *If the external beepers and lights require more than 200 mA DC total, fit a relay.*
- *For information on how to connect NavBus, refer to the NavBus Installation and Operation manual.*

## Setup and test

- 1 Remove the dust covers from the connectors.
- 2 Plug the eight way connectors into their sockets on the back of the display unit:
  - Match the colour on the end of the connector to the colour of the nut on the socket.
  - Hold the plug against the socket and rotate the plug until it slides into the socket.
  - Lock the plug in place by pushing the locking collar towards the socket and turning it a quarter turn clockwise.Nothing will be damaged if a cable is plugged into the wrong socket by mistake.
- 3 If the unit has an external GPS antenna:
  - Plug the gold connector into its socket on the back of the display unit.
  - Hand tighten the locking collar clockwise - do not overtighten.

- 4 If the display unit is bracket mounted:
  - i Hold the display unit in place on the mounting bracket shaft, with the rubber washer clamped between the bracket and the display unit.
  - ii Adjust the tilt and rotation of the display unit for best viewing and hand tighten the knob.
- 5 Remove the dust cover. Turn the TRACKER on (see section 2-1).
- 6 Insert any required C-MAP™ chart card (see section 1-2).
- 7 When the TRACKER is turned on for the first time, the TRACKER displays an installation menu of setup data:
  - i Select the language to use.
  - ii Change the setup data if necessary:
    - Select the data item to change.
    - Use the cursor keys to change the data.
    - Press **ENT**.
  - iii When the setup data is correct, press **ESC**.These installation options can be changed later, through the setup menu (see section 13).
- 8 At the satellite display, check that it picks up GPS satellites. Wait for the GPS receiver to start up and the fix type to change from 'Acquiring' to 'GPS fix'. This should take less than two minutes (see section 7).
- 9 If the TRACKER is to send NMEA data to an autopilot, set this up (see section 13-8).
- 10 If the TRACKER is part of a NavBus system, set the backlight group. Otherwise turn NavBus off (see section 13-8).
- 11 Go on a test run to check that the navigation equipment works correctly, particularly when a radio transmitter or radar is used.

## Installation

### Power/data cable (black locking collar)

#### Pin Wire Signal

| Pin | Wire   | Signal  |
|-----|--------|---|
| 1   | Black  | Ground (power negative, NMEA)   |
| 2   | Brown  | Power out, 9 V DC   |
| 3   | White  | NMEA out, to autopilot/radar  |
| 4   | Blue   | NavBus - or NMEA 2 input  |
| 5   | Red    | Positive power in, 11 to 16.6 V DC  |
| 6   | Orange | NavBus +  |
| 7   | Yellow | Auto power in (connect to positive power in to enable auto power)         |
| 8   | Green  | External beeper or light out, switched to ground, 30 V DC, 200 mA maximum |

**Note:** Shield is connected to pin 1, black wire

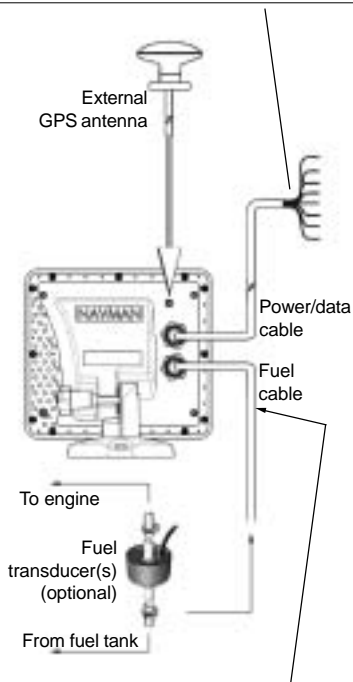

### Fuel cable (white locking collar)

#### Pin Wire Signal

| Pin | Wire  | Signal        |
|-----|-------|---------------|
| 1   | Black | Ground (NMEA) |
| 3   | White | NMEA1 input   |

**Note:** Shield is connected to pin 1, black wire

## Basic Wiring

**Black wire:** Connect this to the negative battery terminal.

**Red Wire:** Connect this to the 12 V positive battery terminal after the main switch. Fit a 1 Amp fuse as shown.

**Yellow wire:** Connect this to the black wire.

Power on the TRACKER manually whenever the main switch is on.

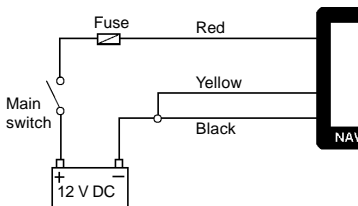

## Auto Power Wiring

**Black wire:** Connect this to the negative battery terminal.

**Red Wire:** Connect this to the 12 V positive battery terminal after the main switch. Fit a 1 Amp fuse as shown.

**Yellow Wire:** Connect to the ignition switch.

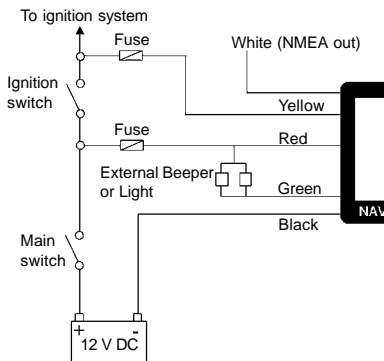

# Appendix A - Specifications

## Physical

- Size 179.5 mm H x 195 mm W x 54 mm D (7.06" x 7.6" x 2.1").
- Weight, display unit 20 oz (600 g).
- Display: 6.4" diagonal, TFT colour, 234 x 320 pixels.

## Electrical

- Power supply 11 to 18 V DC; current at 13.6 V with full backlight: < 600 mA.
- External beeper or light output, switched to ground, 30 V DC, 200 mA maximum.

## Operating Temperature

- 0°C to 50°C (32°F to 122°F).

## Chart and user cards

- C-MAP™ NT cards and NT+ cards.
- 3.3 V C-MAP™ user cards.

## Waypoints

- Up to 3000, with default or user-defined alphanumeric names up to eight characters.

## Routes

- 25 Routes, with up to 50 points each

## Tracks

- By time or distance, one track of 2000 points and four of 500 points.

## Alarms

- Arrival radius, anchor, XTE, danger, low fuel (optional); individually controlled
- Loss of GPS/DGPS fix (fixed alarms).

## Chart datums

- 140 Chart datums (see below).
- One user-defined map shift.

## Chart scale

- 0.05 to 4096 nm for chart (chart dependent) down to 0.01 nm in plotter mode.

## Fuel Computer

 (Optional fuel transducer required)

- Outboard carburetted two stroke petrol/gasoline engines: 30 to 300 hp.
- Outboard four stroke petrol/gasoline engines: 90 to 300 hp.
- Inboard petrol/gasoline engines: 50 to 300 hp.
- Minimum flow rate: 5 litres per hour.

## Standards compliance

- EMC compliance
  - USA (FCC): Part 15 Class B.
  - Europe (CE): EN50081-1, EN50082-1.
  - New Zealand and Australia (C Tick): AS-NZS 3548.
- Environment: IP67/CFR46 (with card holder and connections in place).

## NavBus

- Connection to other NAVMAN instruments.

## NMEA

- NMEA 0183 ver 2.
- Input, from GPS or DGPS receiver: GSA, GSV, GTA, RMC.
- Input, from a depth sounder: SDDPT (preferred) or SDDBT.
- Output, for autopilot or other instrument: APA, APB, GGA, GLL, GSA, GSV, RMB, RMC, BWR, VTG, XTE.

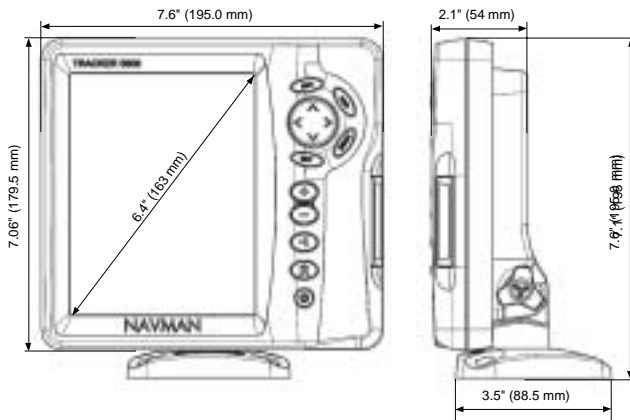

## List of datums

|               |                |               |               |                |                |
|---------------|----------------|---------------|---------------|----------------|----------------|
| ADINDAN       | AFGOOYE        | AIN EL ABD 70 | AM.SAMOA 1962 | ANNA 1 AS. 65  | ANTIGUA AS. 43 |
| ARC 1950      | ARC 1960       | AS.BEACON 'E' | AS.DOS 71/4   | AS.STATION 52  | AS.TERN ISL.   |
| ASCENS.ISL.58 | AUS.GEOD. 66   | AUS.GEOD. 84  | AYABELLE      | BELLEVUE (IGN) | BERMUDA 1967   |
| BISSAU        | BOGOTA OBS.    | BUKIT RIMPAH  | C. CANAVERAL  | CAMP AREA AS.  | CANTON AS. 66  |
| CAPE          | CARTHAGE       | CHATHAM 1971  | CHUA ASTRO    | CMP.INCHAUSPE  | CORR. ALEGRE   |
| DABOLA        | DECEPTION IS   | DJAKARTA      | DOS 1968      | EASTER ISL.67  | ESTONIA 1937   |
| EUROPEAN 1950 | EUROPEAN 1979  | F.THOMAS 1955 | FINNISH (KKJ) | GAN 1970       | GEODETIC 1949  |
| GRACIOSA BASE | GUAM 1963      | GUNUNGSEGARA  | GUX 1 ASTRO   | HERAT NORTH    | HERMANSKOGE    |
| HJORSEY 1955  | HONG KONG 63   | HU-TZU-SHAN   | IGN 1954      | IGN47          | IGN47-51       |
| IGN72         | INDIAN         | INDIAN 1954   | INDIAN 1960   | INDIAN 1975    | INDONES. 1974  |
| IRELAND 1965  | ISTS 73 AS.69  | ISTS AS. 1968 | JOHNSTON 1961 | KANDEWALA      | KERGUELEN 1949 |
| KERTAU 1948   | KUSAIE AS. 51  | L.C. 5 ASTRO  | LEIGON        | LIBERIA 1964   | LISBOA         |
| LUZON         | M. MERCURY 68  | MAHE 1971     | MASSAWA       | MERCHICH       | MERCURY 1960   |
| MIDWAY AS. 61 | MINNA          | MONTERRAT 58  | M'PORALOKO    | N. SAHARA 1959 | NAD 1927       |
| NAD 1983      | NAHRWAN        | NANKING 1960  | NAPARIMA, BWI | NEW P. SANTO   | NORWEGIAN      |
| O.S. IRELAND  | O.S.G.B. 1936  | OBSERVAT.1996 | OLD EGYPTIAN  | OLD HAWAIIAN   | OMAN           |
| P.TE NOIRE 48 | P.TO SANTO 36  | PICO NIEVES   | PITCAIRN 1967 | POINT 58       | POLISH         |
| POTSDAM       | PRV.S.AMER.56  | PRV.S.CHIL.63 | PUERTO RICO   | PULKOVO 1942   | QATAR NATION.  |
| QORNOQ        | REUNION        | REV. KERTAU   | REV. NAHRWAN  | ROME 1940      | RT 90          |
| S.LEONE 1960  | S. AMERICAN 69 | SANTO(DOS) 65 | SAO BRAZ      | SAPPER H. 43   | SCHWARZECK     |
| SELVAGEM 1938 | SGS 85         | S-JTSK        | SOUTH ASIA    | SWEDISH        | SWISS CH-1903  |
| TANANARIVE 25 | TIMBALAI 1948  | TOKYO         | TRISTAN 1968  | VITI LEVU 16   | VOIROL 1875    |
| VOIROL 1960   | WAKE ISL.1952  | WAKE ISL.1952 | WAKE-ENIWETOK | WGS 1972       | WGS 1984       |
| YACARE        | ZANDERIJ       |               |               |                |                |

## Appendix B - Troubleshooting

This troubleshooting guide assumes that you have read and understood this manual.

It is possible in many cases to solve difficulties without having to send the unit back to the manufacturer for repair. Please follow this troubleshooting section before contacting the nearest NAVMAN dealer.

There are no user serviceable parts. Specialised methods and testing equipment are required to ensure that the unit is reassembled correctly and is waterproof. Repairs to the unit must only be carried out by a service centre approved by Navman NZ Limited. Users who service the TRACKER themselves will void the warranty.

When contacting a NAVMAN dealer for service, quote the software version number and date which is given on the about display (see section 12).

More information can be found on our Website: [www.navman.com](http://www.navman.com)

### 1 TRACKER will not switch on:

- a Cables not connected or plugged into wrong sockets in display unit. Match the plug colours.
- b TRACKER wired for auto power. TRACKER will turn on and off with boat power.
- c Backlight too low. Turn on full (see section 2-3).
- d Fuse blown or circuit breaker tripped.
- e Faulty wiring.

### 2 TRACKER will not switch off:

- TRACKER wired for auto power. TRACKER will turn on and off with boat power.

### 3 TRACKER turns off unexpectedly:

- a Power/data cable not plugged in properly.
- b Loose or corroded connection in power/data cable. Check cable.

### 4 The language on the display is wrong:

- Choose the correct language (see section 13-1).

### 5 No GPS fix or long time to get fix at startup:

- a May occur occasionally if the antenna does not have a clear view of the sky. The satellite positions are constantly changing.
- b Antenna cable not connected to display unit.
- c Restart GPS (see section 13-3).

### 6 TRACKER GPS position different from true position by more than 10 m (33 ft):

- a TRACKER in simulate mode. Turn simulate mode off (see section 13-11).
- b The normal error in GPS position will exceed 10 m (33 ft) for about 5% of the time.

- c Under special circumstances the US Department of Defence may introduce a deliberate and changing error in the GPS positions of up to 300 m (1000 ft).

### 7 TRACKER position different from same position on local charts:

- a TRACKER in simulate mode. Turn simulate mode off (see section 13-10).
- b Incorrect chart datum. Select the correct chart datum (see section 13-2).
- c Map shift has been applied wrongly. Clear map shift, then reapply if necessary (see section 13-2).

### 8 Can not see boat on chart:

- Press ESC to switch to centre on boat mode (see section 3-1-1).

### 9 The time or date on satellite display is wrong or off:

- a No GPS fix.
- b In simulate mode. Turn simulate mode off (see section 13-10).
- c Local time offset is wrong (see section 13-9). The Local Time Offset must be changed when daylight saving time starts or ends.

### 10 Autopilot not responding to TRACKER; no NMEA output:

- a NMEA output disabled or the required NMEA sentences are not turned on. Check NMEA settings (see section 13-8).
- b Check that the instrument is connected correctly.

### 11 Depth not displayed:

- a Set a data field to Depth in chart, highway or data displays.
- b Check depth sounder is working and connected properly.

### 12 No fuel functions available:

- a Fuel kit not installed.
- b Fuel functions not enabled. Set Num Engines to 1 or 2 (see section 13-4).
- c Cables not connected or plugged into wrong sockets in display unit. Match the plug colours.

### 13 Fuel Used or Remaining seem wrong:

- a The engine has been run while the TRACKER is turned off and it has not recorded the fuel use. Wire the auto power option (see section 15-3).
- b Fuel may be surging back and forward through a transducer in rough seas. Try installing a one way valve between the fuel transducer and the fuel tank.

- c Tank Full or Set Remaining has not been set every refuelling.
  - d When refuelling, air pockets may have prevented the tank filling completely.
  - e Fuel transducers wear out over time and should be replaced every 5000 litres (1316 US gallons) of fuel as a guide.
- 14 No or low fuel flow reading:**
- a Check the fuel cable connectors are securely plugged in and the locking ring is locked in place.
  - b Clogged fuel transducer. To clean a transducer, remove it from the line and gently blow through it in the opposite direction to the fuel flow. Fit a fuel filter before the transducer.
  - c Inspect the fuel cable(s) for damage.
  - d Dirty fuel filter.
  - e Fuel transducer has been exposed to excessive heat or vibration.

**15 Only one flow rate value shown for a twin engine installation:**

- Set Num Engines to 2 (see section 13-4).

**16 Erratic fuel flow readings:**

- a The fuel transducer must not be mounted too close to the fuel pump(s) and not subject to excess vibration.
- b Check for air leaks in the fuel hose(s) or fuel pick-up(s) in the tank(s).
- c The Flow Filter has not been set to suit the engine(s) (see section 13-4). Increase the Flow Filter value until a steady flow rate is indicated.

**17 TRACKER operates erratically or unexpectedly:**

- Setup data incorrect. Reset to factory defaults (see section 13-1).

## Appendix C - Glossary and navigation data

### Glossary

**Attention Area** - An important area on a chart, such as a restricted anchorage or a shallow area (see section 13-2).

**Bathymetric line** - A depth contour line on the chart.

**Chart card** - A plug-in card that stores chart data for a region (see section 1-2).

**C-MAP™ chart card** - See Chart card.

**C-MAP™ user card** - See User card.

**Cursor** - A  symbol on the display (see section 3-1-1).

**DGPS** - Differential Global Positioning System. A navigation tool based on GPS with some errors corrected (see section 7).

**Goto** - A simple way of navigating straight to a waypoint or to the cursor position (see section 3-3).

**GPS** - Global Positioning System. A satellite-based navigation tool (see section 7).

**Leg** - The straight segments of a route between waypoints. A route with four waypoints has three legs.

**MOB** - Man overboard.

**MOB function** - Starts navigating back to the place where someone fell overboard (see section 2-4).

**NavBus** - A way of connecting NAVMAN instruments together to share data (see section 14).

**NMEA** - National Marine Electronics Association.

**NMEA 0183** - A standard for interfacing marine electronic devices (see section 14).

**Route** - Two or more waypoints linked in sequence to form a course for the boat (see section 10).

**User card** - A plug-in card that stores waypoints, routes and tracks (see section 1-2).

**UTC** - Universal Time Coordinated or Coordinated Universal Time, which is a standard world time, formerly called Greenwich Mean Time (GMT).

**Waypoint** - A user-definable chart position (see section 9).

## Navigation data

The boat is sailing from the start to the destination and has moved off the plotted course from the start to the destination.

|      |                            |   |
|------|----------------------------|---|
| BRG  | Bearing to Destination     | Bearing to the destination from the boat.   |
| +BRG | Bearing to cursor          | Bearing to cursor from boat (cursor mode, see section 3-1-1)  |
| CDI  | Course Deviation Indicator | When the boat is navigating to a point, the chart and highway displays show a parallel line on either side of the plotted course. These two lines are called the Course Deviation Indicator (CDI) lines. The distance from the plotted course to a CDI line is the CDI scale.   |
|      |                            | Set the CDI scale (see section 13-2) to the maximum distance that the boat should deviate from the plotted course. The chart and highway displays show the CDI lines, which are like a highway over the water where the boat will move. The displays show how far the boat has deviated from the plotted course and if the boat is approaching a CDI line. If the XTE alarm is enabled (see section 13-6) an alarm will sound if the boat reaches a CDI line. |
| COG  | Course Over Ground         | Direction in which the boat is moving over the ground.  |
| CTS  | Course To Steer            | Optimum course to steer to return to the plotted course.  |
| DTG  | Distance To Go             | Distance from the boat to the destination.  |
| ETA  | Expected Time of Arrival   | At the destination, assuming that SOG and COG remain constant.  |
| +RNG | Range to cursor            | Distance from boat to cursor (cursor mode, see section 3-1-1)   |
| SOG  | Speed Over Ground          | Current boat speed over the ground. This is not necessarily the same as the boat speed through the water nor the speed at which it is approaching the destination.  |
| STR  | Steering                   | The difference between COG and CTS.   |
| TTG  | Time To Go                 | The estimated time to reach the destination.  |
| XTE  | Cross Track Error          | The distance from the boat to the nearest point of the plotted course. XTE may have a letter: R means steer to the right to return to the plotted course, L means steer to the left.  |
| VMG  | Velocity Made Good         | The speed at which the boat is approaching the destination.   |

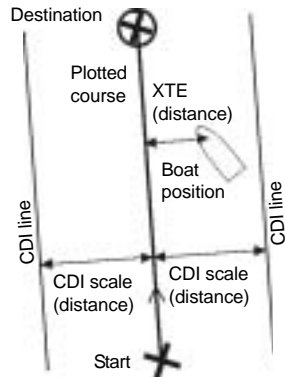
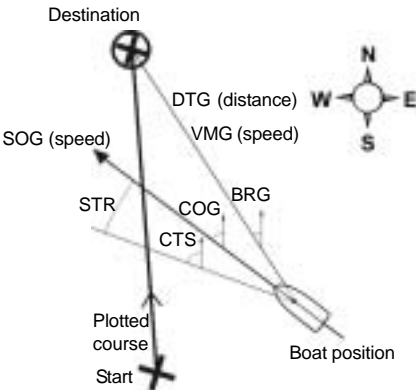

**NORTH AMERICA**

NAVMAN USA INC.  
18 Pine St. Ext.  
Nashua, NH 03060.  
Ph: +1 603 577 9600  
e-mail: sales@navmanusa.com

**OCEANIA**

New Zealand  
Absolute Marine Ltd.  
Unit B, 138 Harris Road,  
East Tamaki, Auckland.  
Ph: +64 9 273 9273  
e-mail:  
navman@absolutemarine.co.nz

Australia  
NAVMAN AUSTRALIA PTY  
Limited  
Unit 6 / 5-13 Parsons St,  
Rozelle, NSW 2039, Australia.  
Ph: +61 2 9818 8382  
e-mail: sales@navman.com.au

**SOUTH AMERICA**

Argentina  
Costanera UNO S.A.  
Av Presidente R Castillo y  
Calle 13  
1425 Buenos Aires, Argentina.  
Ph: +54 11 4312 4545  
e-mail:  
purchase@costanerauno.com.ar  
Website:  
www.costanerauno.ar

Brazil  
REALMARINE  
Estrada do Joa 3862,  
CEP2611-020,  
Barra da Tijuca, Rio de Janeiro,  
Brasil.  
Ph: +55 21 2483 9700  
e-mail:  
vendas@marinedepot.com.br

Equinautic Com Imp Exp de  
Equip Nauticos Ltda.  
Av. Diario de Noticias 1997 CEP  
90810-080, Bairro Cristal, Porto  
Alegre - RS, Brasil.  
Ph: +55 51 3242 9972  
Fax: +55 51 3241 1134  
e-mail:  
equinautic@equinautic.com.br

**ASIA**

China  
Peaceful Marine Electronics Co. Ltd.  
Hong Kong, Guangzhou,  
Shanghai, Qindao, Dalian.  
E210, Huang Hua Gang Ke Mao  
Street, 81 Xian Lie Zhong Road,  
510070 Guangzhou, China.  
Ph: +86 20 3869 8784  
e-mail:  
sales@peaceful-marine.com  
Website:  
www.peaceful-marine.com

Korea  
Kumho Marine Technology Co. Ltd.  
# 604-816, 3F, 1117-34,  
Koejung4-Dong, Saha-ku  
Pusan, Korea  
Ph: +82 51 293 8589  
e-mail: info@kumhomarine.com  
Website:  
www.kumhomarine.com

Singapore and Malaysia  
RIQ PTE Ltd.  
Block 3007, Ubi Road 1  
#02-440, Singapore 408701  
Ph: +65 6741 3723  
HP: +65 9679 5903  
e-mail: riq@postone.com

Thailand  
Thong Electronics (Thailand)  
Company Ltd.  
923/588 Thaprong Road,  
Mahachai,  
Muang, Samutsakhon 74000,  
Thailand.  
Ph: +66 34 411 919  
e-mail: thonge@cscoms.com

Vietnam  
Haidang Co. Ltd.  
16A/AIE, Ba thung hai St.  
District 10, Hochiminh City.  
Ph: +84 8 86321 59  
e-mail:  
sales@haidangvn.com  
Website: www.haidangvn.com

Taiwan  
Seafirst International  
Corporation  
No.281, Hou-An Road  
Chien-Chen Dist.  
Kaohsiung, Taiwan  
R.O.C.  
Ph: +886 7 831 2688  
e-mail:  
seafirst@seed.net.tw

**MIDDLE EAST**

Lebanon and Syria  
Letro, Balco Stores  
Moutran Street, Tripoli  
VIA Beirut.  
Ph: +961 6 624512  
e-mail: balco@cyberia.net.lb

United Arab Emirates  
Kuwait, Oman, Iran & Saudi Arabia  
Abdullah Moh'd Ibrahim  
Trading, opp Creak Rd.  
Baniyas Road, Dubai.  
Ph: +971 4 229 1195  
e-mail: mksq99@email.com

**AFRICA**

South Africa  
Pertec (Pty) Ltd Coastal,  
Division No.16 Paarden Eiland Rd.  
Paarden Eiland, 7405  
Postal Address: PO Box 527,  
Paarden Eiland 7420  
Cape Town, South Africa.  
Ph: +27 21 511 5055  
e-mail: info@kfa.co.za

**EUROPE**

France, Belgium and  
Switzerland  
PLASTIMO INTERNATIONAL  
15, rue Ingénieur Verrière,  
BP435,  
56325 Lorient Cedex.  
Ph: +33 2 97 87 36 36  
e-mail: plastimo@plastimo.fr  
Website: www.plastimo.fr

Germany  
PLASTIMO DEUTSCHLAND  
15, rue Ingénieur Verrière  
BP435  
56325 Lorient Cedex.  
Ph: +49 6105 92 10 09  
+49 6105 92 10 10  
+49 6105 92 10 12  
e-mail:  
plastimo.international@plastimo.de  
Website: www.plastimo.de

Italy  
PLASTIMO ITALIA  
Nuova Rade spa, Via del Portosao 5  
I-16015 CASELLA SCRIVIA (GE).  
Ph: +39 1096 8011  
e-mail: info@nuovarade.com  
Website: www.plastimo.it

Holland  
PLASTIMO HOLLAND BV.  
Industrieweg 4-6,  
2871 RP SCHOONHOVEN.  
Ph: +31 182 320 522  
e-mail: info@plastimo.nl  
Website: www.plastimo.nl

United Kingdom  
PLASTIMO Mfg. UK Ltd.  
School Lane - Chndlers Ford  
Industrial Estate,  
EASTLEIGH - HANTS S053 ADG.  
Ph: +44 23 8026 3311  
e-mail: sales@plastimo.co.uk  
Website: www.plastimo.co.uk

Sweden, Denmark or Finland  
PLASTIMO NORDIC AB.  
Box 28 - Lundenvägen 2,  
47321 HENAN.  
Ph: +46 304 360 60  
e-mail: info@plastimo.se  
Website: www.plastimo.se

Spain  
PLASTIMO ESPAÑA, S.A.  
Avenida Narcís Monturiol, 17  
08339 VILASSAR DE DALI,  
(Barcelona).  
Ph: +34 93 750 75 04  
e-mail: plastimo@plastimo.es  
Website: www.plastimo.es

Portugal  
PLASTIMO PORTUGAL  
Avenida de India N°40  
1300-299 Lisbon  
Ph: +351 21 362 04 57  
e-mail: email :  
plastimo@siroco-nautica.pt

Other countries in Europe  
PLASTIMO INTERNATIONAL  
15, rue Ingénieur Verrière  
BP435  
56325 Lorient Cedex, France.  
Ph: +33 2 97 87 36 59  
e-mail:  
plastimo.international@plastimo.fr  
Website: www.plastimo.com

REST OF WORLD /  
MANUFACTURERS  
NAVMAN NZ Limited  
13-17 Kawana St. Northcote.  
P.O. Box 68 155 Newton,  
Auckland, New Zealand.  
Ph: +64 9 481 0500  
e-mail:  
marine.sales@navman.com  
Website:  
www.navman.com

Made in New Zealand  
MN000193C

TRACKER 5600



Lon 174° 44.535' E

Lat 36° 48.404' S

# NAVMAN

